

Fermatic Basic

Jäsrum Prover Gärraum



Reservdelista
Spare Parts List
Ersatzteilliste

Förutom denna RESERVDLSLISTA finns följande teknisk dokumentation:
DRIFT- SKÖTSEL- och INSTALLATIONSANVISNING 5:3493
ELKOPPLINGSSHEMA (medföljer jäsrummet)

Vid förfrågan eller fel - kontakta installatören eller agenten i första hand
eller

SVEBA-DAHLEN AB
513 82 FRISTAD
Tel. 033 151500
Fax 033 151599

Tillverkaren förbehåller sig rätten till mått- och konstruktionsändringar

The following technical documentation is available in addition to these
OPERATING, MAINTENANCE AND INSTALLATION MANUAL 5:3493
WIRING DIAGRAM (supplied with the prover)

Please direct all your questions, comments or technical problems regarding this
product to the SVEBA-DAHLEN dealer or directly to

SVEBA-DAHLEN AB
SE-513 82 Fristad
Sweden
Tel. +46 33 151500
Fax +46 33 151599

Subject to changes without notice

Außer dieser Betriebs- Wartung- und Installationsanleitung gibt es die folgenden
technischen Beschreibungen:
BETRIEB, WARTUNG, INSTALLATION 5:3493
ELEKTR. SCHALTPLAN (dem Gärraum beigefügt)

Bei Fragen oder Störungen wenden Sie sich bitte zuerst an Ihren Installateur oder
Fachhändler oder an

SVEBA-DAHLEN AB
SE-513 82 FRISTAD,
Schweden
Tel.-Nr.:+46 33 151500
Fax-Nr.: +46 33 151599

Der Hersteller behält sich das Recht auf Maß- und Konstruktionsänderungen vor.

Instrumentpanel	Instrument panel	Instrumentafel ..	4
El koppl.låda	Electrical box	El.Schaltkasten ..	6
Dörr	Door	Tür ..	8
Dysrör	Nozzle pipe	Düsenleitung .	12
Invändiga detaljer	Interior parts	Inwendige Teile .	14
Monteringssats	Mounting set	Montage satz .	16

	Instrumentpanel	Instrument panel	Instrumentafel	
---	-----------------	------------------	----------------	--

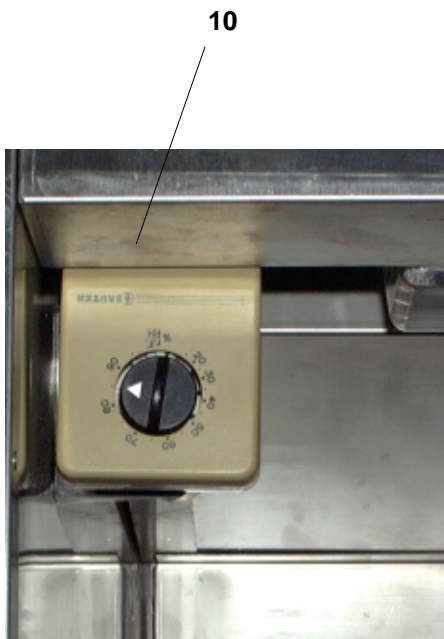
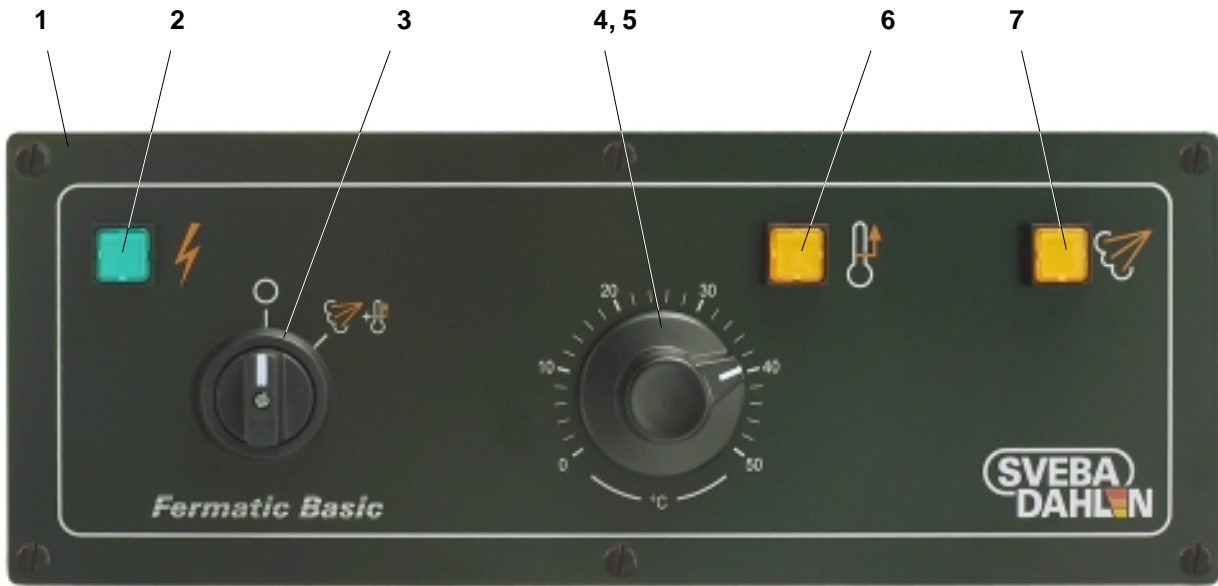

Pos Fig. Teil	Best.nr Order No Best.Nr	Benämning	Description	Benennung	Ant. Qty. Anz.	Anm. Notes Anm.
1	113634-01	Instrumentpanel	Instrument panel	Instrumententafel		
2	60506-801	Signallampa grön	Pilot lamp green	Signallampe grün		
3	317026-10	Strömbrytare	Switch	Schalter		
4	60438-800	Vred	Knob	Drehknopf		
5	60280-800	Termostat	Thermostat	Termostat		
6	60506-800	Signallampa gul	Pilotlamp yellow	Signallampe gelb		
7	60506-800	Signallampa gul	Pilotlamp yellow	Signallampe gelb		
10	412564-01	Hygrostat	Humidity control	Hygrostst		

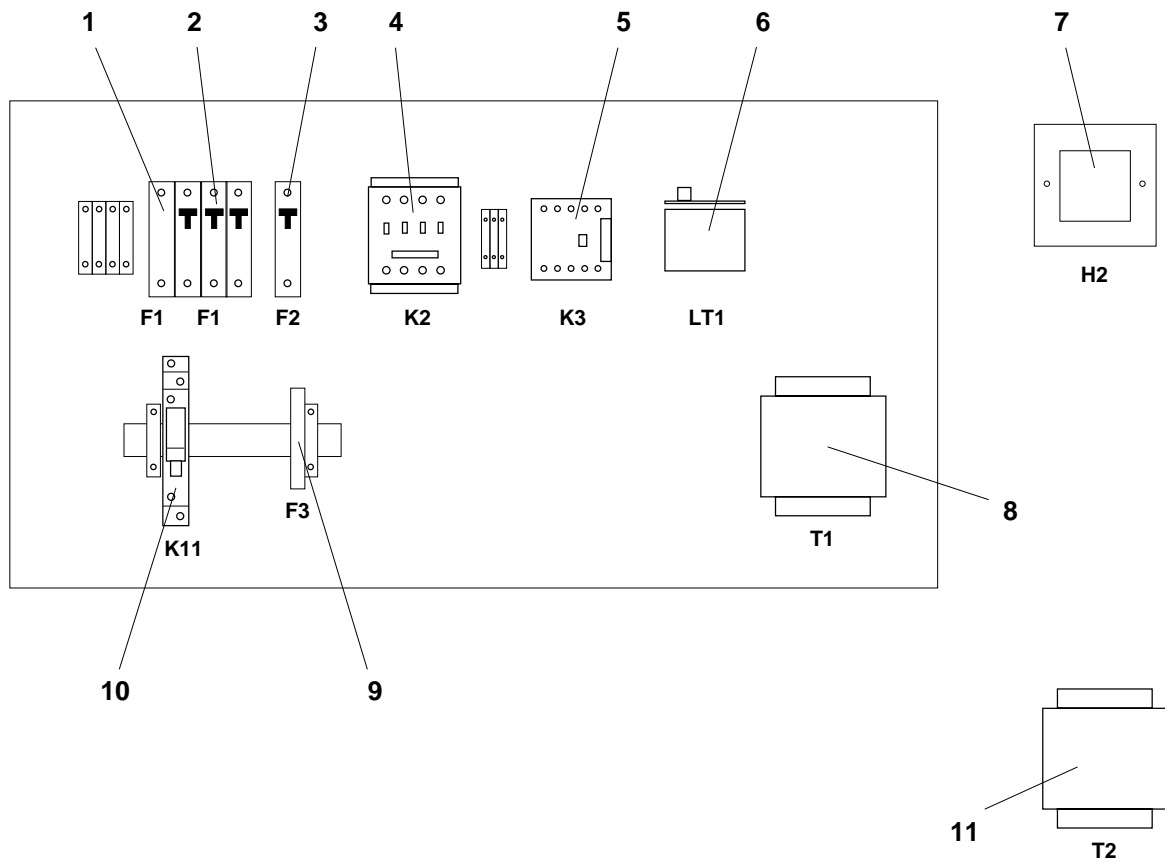

Pos Fig. Teil	Best.nr Order No Best.Nr	Benämning	Description	Benennung		Anm. Notes Anm.
1	60232-891	Shuntutlösare	Trip unit	Arbeitsstrom Auslöser	F1	
2	60232-811	Säkring automat 16A	Circuit breaker 16A	Automatsicherung 16A	F1	
2	60232-815	Säkring automat 20A	Circuit breaker 20A	Automatsicherung 20A	F1	
2	60232-819	Säkring automat 25A	Circuit breaker 25A	Automatsicherung 25A	F1	
2	60232-823	Säkring automat 32A	Circuit breaker 32A	Automatsicherung 32A	F1	
2	60232-827	Säkring automat 40A	Circuit breaker 40A	Automatsicherung 40A	F1	
2	60232-831	Säkring automat 50A	Circuit breaker 50A	Automatsicherung 50A	F1	
2	60232-834	Säkring automat 63A	Circuit breaker 63A	Automatsicherung 63A	F1	
3	60232-805	Säkring automat 1x10	Circuit breaker 1x10	Automatsicherung 1x10	F2	
3	60232-806	Säkring automat 2x10	Circuit breaker 2x10	Automatsicherung 2x10	F2	
4	60607-800	Kontaktor	Contactora	Schüts	K2	24V 25/20A
4	60607-801	Kontaktor	Contactora	Schüts	K2	24V 40A
4	60607-802	Kontaktor	Contactora	Schüts	K2	24V 50A
5	60606-800	Kontaktor	Contactora	Schüts	K3	
6	60603-800	Överhettningsskydd	Overheat protection	Überhitze schutz	LT1	0...200°C
6	60537-800	Fästadapter	Fastening	Befästigung	LT1	
7	60729-800	Ljudsignal	Sound signal	Akustisches Signal	H2	
8	60489-817	Transformator	Transformer	Transformator	T1	230/24V 60VA
9	60604-801	Glasrörsäkring 10A	Glass tube fuse 10A	Glasrohrsicherung 10A	F3	
10	60532-809	Socket	Holder	Socket	K11	
10	60616-802	Miniatyrrelä	Mini relay	Miniatyr Relais	K11	
11	412333-03	Transformator	Transformer	Transformator	T2	240/220V 500VA
11	412333-05	Transformator	Transformer	Transformator	T2	200/220V 500VA

Anslutningsspänning Connected voltage Anschlußspannung	Värmeeffekt Heating power Hitze leistung	F1	K2
200V	3 kW	20A	25/20A
	6 kW	32A	40A
	9 kW	32A	40A
	12 kW	50A	50A
	18 kW	63A	50A
220V	3 kW	20A	25/20A
	6 kW	32A	40A
	9 kW	32A	40A
	12 kW	40A	50A
	18 kW	50A	50A

Anslutningsspänning Connected voltage Anschlußspannung	Värmeeffekt Heating power Hitze leistung	F1	K2
400V 415V	3 kW	16A	25/20A
	6 kW	20A	25/20A
	9 kW	20A	25/20A
	12 kW	25A	40A
	18 kW	32A	50A

Modell Model Modell
98x100, 98x120, 98x150, 98x200

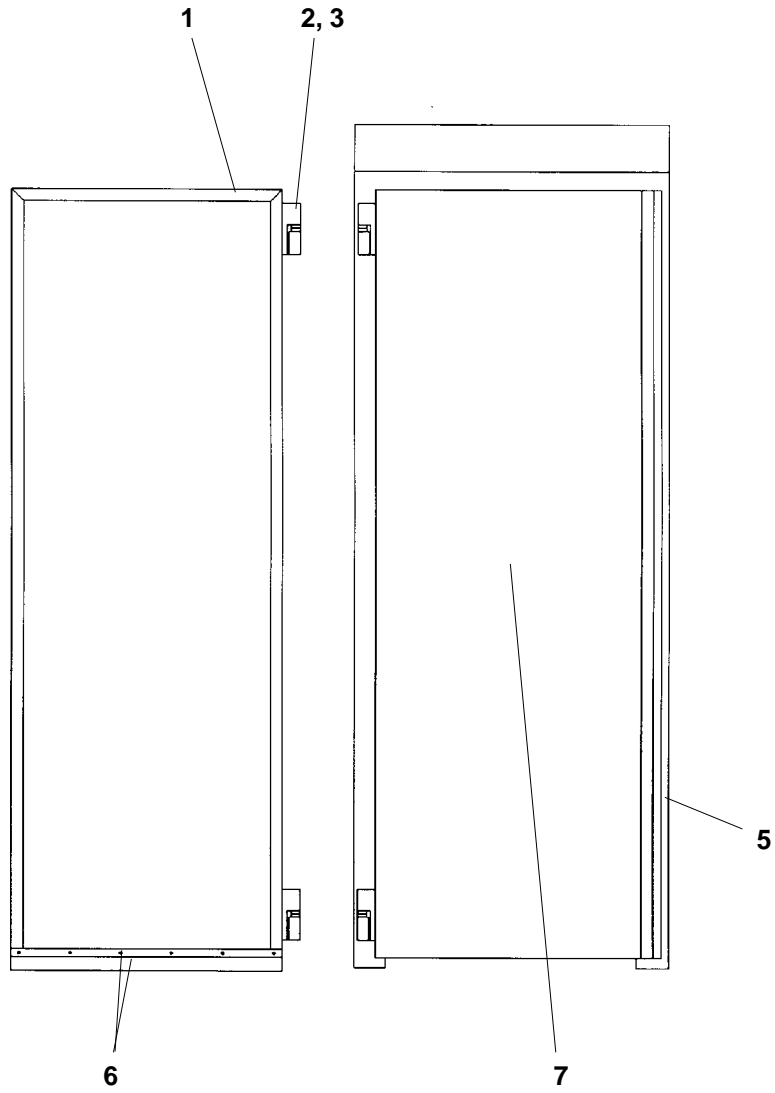

Pos Fig. Teil	Best.nr Order No Best.Nr	Benämning	Description	Benennung	Ant. Qty. Anz.	Anm. Notes Ann.
1	60576-800	Dörrpackning	Door gasket	Tür - Dichtung	1	"98"
2	60577-800	Gångjärn komplett	Hinge complete	Scharnier	2	
3	60032-366	Skruv M6x12	Screw M6x12	Schraube M6x12	12	
5	60610-800	Dörrhandtag	Door handle	Türgriff	1	
6	511223-82	Dörrpackningssats nedre	Door gasket kit lower	Tür - Dichtungsätze untere	1	
7	60578-800	Isolerglas	Insulated glass	Isolierglas	1	OPTION

Modell Model Modell
150x100, 150x120, 150x150, 180x120, 180x210, 180x285,
210x100, 210x150, 210x240

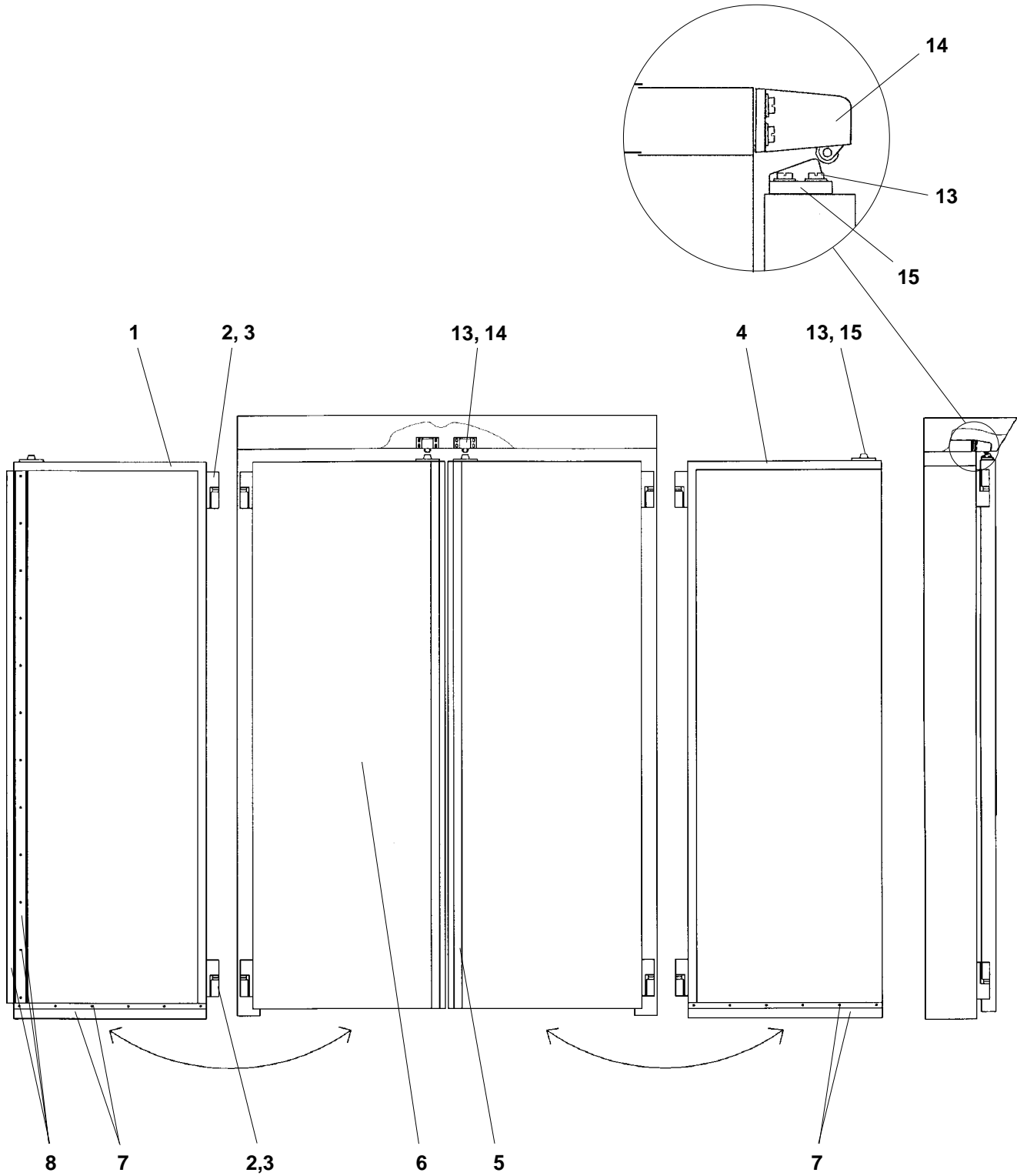

Pos Fig. Teil	Best.nr Order No Best.Nr	Benämning	Description	Benennung	Ant. Qty. Anz.	Anm. Notes Anm.
1	60576-801	Dörrpackning vä.	Door gasket left	Tür - Dichtung links	1	"150"
1	60576-803	Dörrpackning vä.	Door gasket left	Tür - Dichtung links	1	"180"
1	60576-805	Dörrpackning vä.	Door gasket left	Tür - Dichtung links	1	"210"
2	60577-800	Gångjärn komplett	Hinge complete	Scharnier	2	
3	60032-366	Skruv M6x12	Screw M6x12	Schraube M6x12	12	
4	60576-802	Dörrpackning hö.	Door gasket right	Tür - Dichtung recht	1	"150"
4	60576-804	Dörrpackning hö.	Door gasket right	Tür - Dichtung recht	1	"180"
4	60576-806	Dörrpackning hö.	Door gasket right	Tür - Dichtung recht	1	"210"
5	60610-800	Dörrhandtag	Door handle	Türgriff	1	
6	60578-800	Isolerglas	Insulated glass	Isolierglas	1	OPTION
7	511223-82	Dörrpackningssats nedre	Door gasket kit lower	Tür - Dichtungsätze untere	2	
8	511223-80	Dörrpackningssats	Door gasket kit	Tür - Dichtungsätze	1	
13	60030-366	Skruv M6x12	Screw M6x12	Schraube M6x12	4	
14	60579-800	Dörrstängare	Door closer	Türschloss	1	
15	60579-801	Låsklack	Lock hook	Schlosshaken	1	

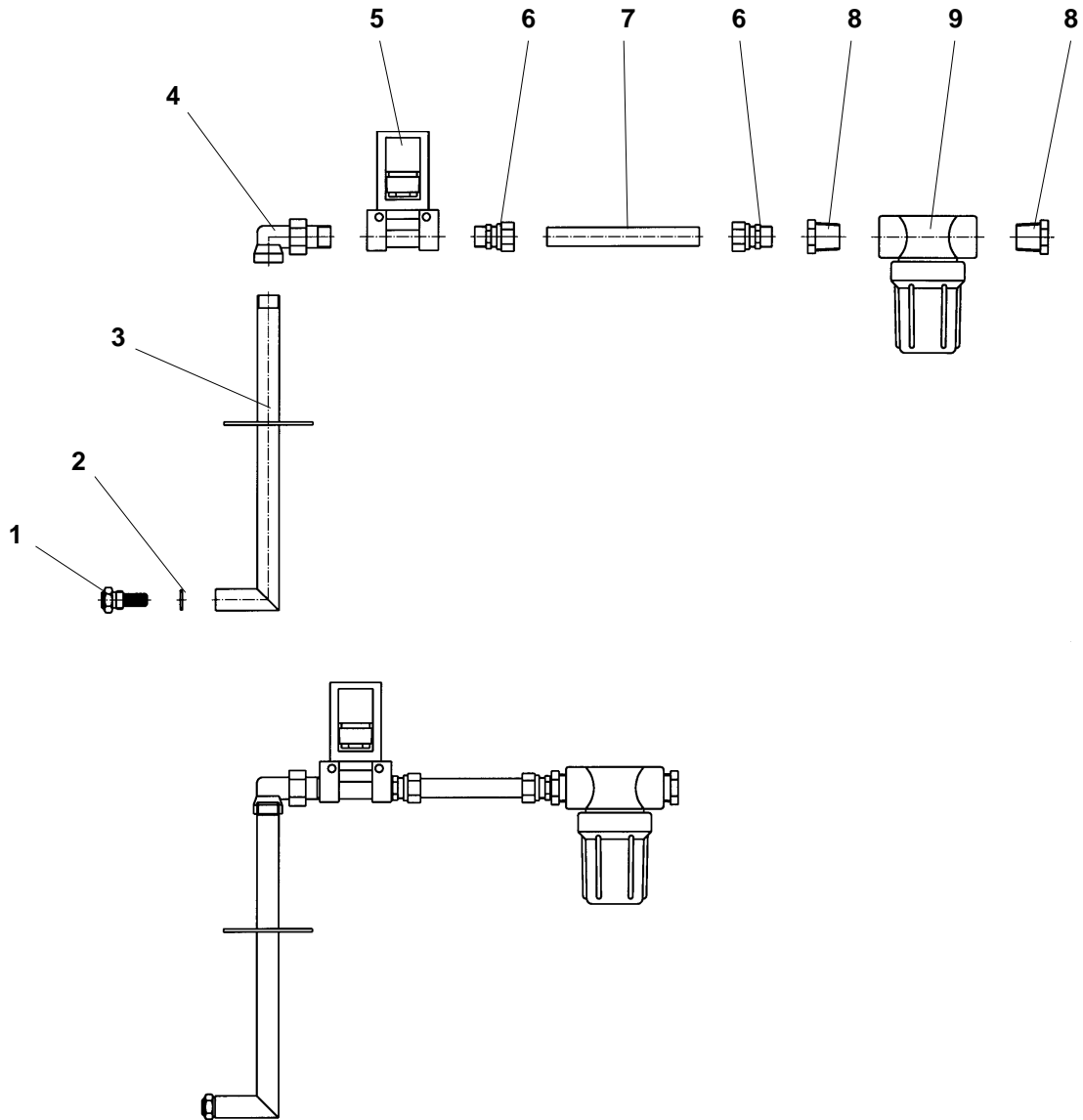

Pos Fig. Teil	Best.nr Order No Best.Nr	Benämning	Description	Benennung	Ant. Qty. Anz.	Anm. Notes Anm.
1	60747-802	Dysa LN2	Water Jet LN2	Duese LN2		
2	60367-210	O-ring	O-ring	O-Ring		
3	321824-80	Dysrör	Nozzle pipe	Düsenleitung		
4	60047-111	Radiatorkoppling 90°	Tube coupling 90°	Rohr- Kupplungs 90°		
5	60270-802	Magnetventil	Solenoid valve	Solenoid Ventile		
6	50140-03	Rak koppling	Tube coupling	Rohr- Kupplungs		12 x R10
7		Kopparrör Ø12x1	Copper pipe Ø12x1	Kupferrohr Ø12x1		L=120mm
8	60749-206	Bussning	Bushing	Hülse		1/2 BSPT x G3/8
9	60748-800	Vätskefilter	Liquid filter	Flüssigkeitsfilter		

1

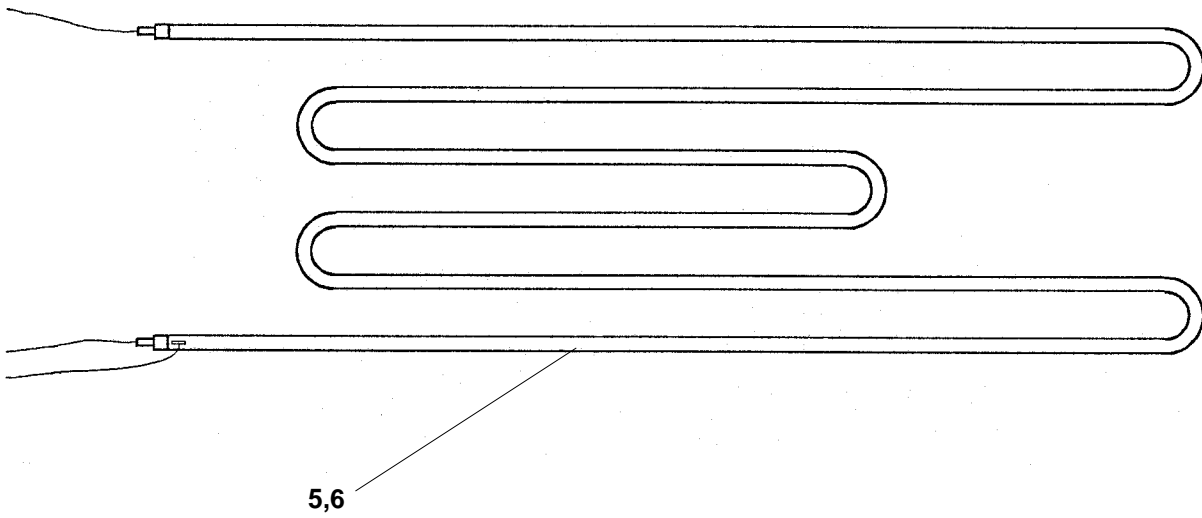
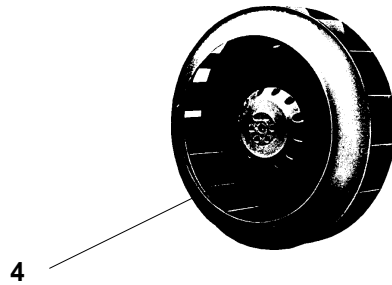
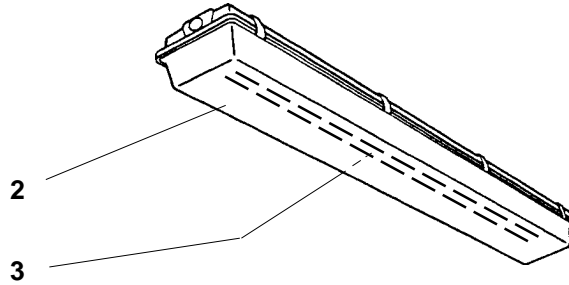

Pos Fig. Teil	Best.nr Order No Best.Nr	Benämning	Description	Benennung	Ant. Qty. Anz.	Anm. Notes Anm.
1	60581-800	Belysningsarmatur komplett	Lighting fitting complete	Beleuchtung komplett	1	OPTION
2	60581-801	Kupa för belysningsarmatur	Shade for lighting fitting	Aussenglocke für Beleuchtung	1	OPTION
3	92002-005	Lysrör	Fluorescent tube	Leuchtröhre	1	590mm 18W OPTION
4	60584-800	Fläkt	Fan	Ventilator	*)	
5	60600-800	Element	Heating element	Heizkörper	**)	3000W 220V
6	60600-801	Element	Heating element	Heizkörper	**)	3000W 400V

Modell	Antal Fläktar	Värme effekt
98 x 100	1	3,0 kW
98 x 120	1	3,0 kW
98 x 150	2	6,0 kW
98 x 200	2	6,0 kW
150 x 100	2	6,0 kW
150 x 150	2	9,0 kW
180 x 100	2	6,0 kW
180 x 120	2	6,0 kW
180 x 210	2	9,0 kW
180 x 285	3	12,0 kW
210 x 100	2	6,0 kW
210 x 150	2	12,0 kW
210 x 240	3	12,0 kW

*) 1 / 98x100, 98x120

2 / 98x150, 98x200, 150x100, 150x150, 180x120, 180x210, 210x100, 210x150

3 / 180x285, 210x240

***) 1 / 98x100, 98x120

2 / 98x150, 98x200, 150x100, 150x150, 180x120, 210x100

3 / 180x210, 180x285, 210x240, 210x150

4 / 210x240

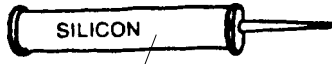

2



3

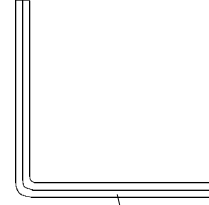

5



10



11



12

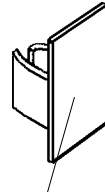

13

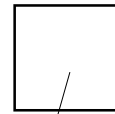

14

Pos Fig. Teil	Best.nr Order No Best.Nr	Benämning	Description	Benennung	Ant. Qty. Anz.	Anm. Notes Anm.
2	65100-800	Silikon	Silicone	Silikon	1	
3	60585-800	Täckplugg	Cover plug	Abdeckpropfen	20	
5	60587-800	Sexkantvinkel	Hexagon key	Sechskantschlüssel	1	8 mm
10	60586-344	Skruv	Screw	Schraube	10	CSS B8x16 A2
11	60602-416	Skruv	Screw	Schraube	3	RXS B10x25 A2
12	60593-800	Plugg 8 x 40	Plug 8 x 40	Pfropf 8 x 40	3	
13	60577-801	Täckbricka gångjärn	Covering plate hinge	Abdeckblech Scharnier	*)	
14	420542-01	Schimsplåt	Plate	Platte	20	80 x 80mm

*) 4 / "98"
8 / "150", "180"
12 / "210"