

FERMATIC

Kyl-Jäsrum Retarder-Prover Kühl-Gärraum

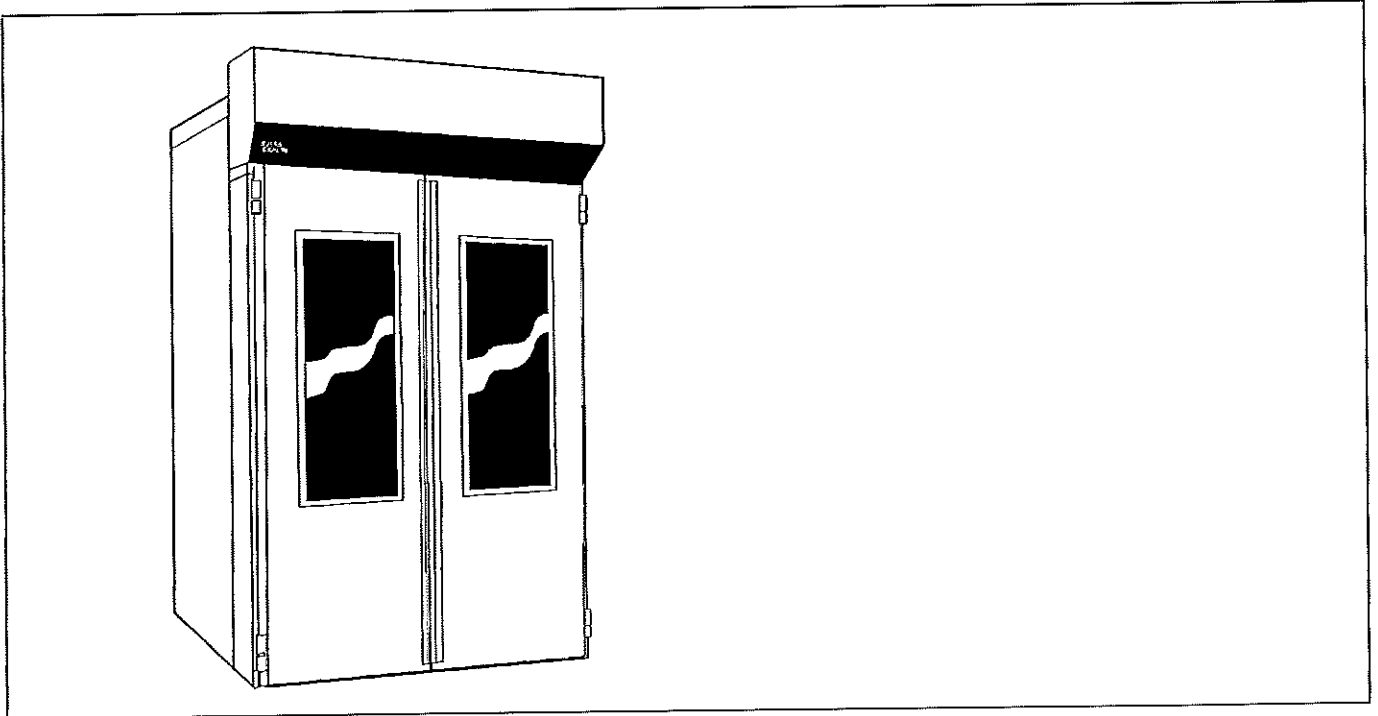

Reservdelista
Spare Parts List
Ersatzteilliste

Förutom denna RESERVDLSLISTA finns följande teknisk dokumentation:
DRIFT- SKÖTSEL- och INSTALLATIONSANVISNING 5:3510
ELKOPPLINGSSHEMA (medföljer kyl-jäsrummet)

Vid förfrågan eller fel - kontakta installatören eller agenten i första hand eller

SVEBA-DAHLEN AB
513 82 FRISTAD
Tel. 033 266790
Fax 033 266776

Tillverkaren förbehåller sig rätten till mått- och konstruktionsändringar

The following technical documentation is available in addition to these
OPERATING, MAINTENANCE AND INSTALLATION MANUAL 5:3510
WIRING DIAGRAM (supplied with the retarder-prover)

Please direct all your questions, comments or technical problems regarding this
product to the SVEBA-DAHLEN dealer or directly to

SVEBA-DAHLEN AB
S-513 82 Fristad
Sweden
Tel. +46 33 26 67 90
Fax +46 33 26 67 76

Subject to changes without notice

Außer dieser Betriebs- Wartung- und Installationsanleitung gibt es die folgenden
technischen Beschreibungen:
BETRIEB, WARTUNG, INSTALLATION 5:3510
ELEKTR. SCHALTPLAN (dem Kühl-Gärraum beigelegt)

Bei Fragen oder Störungen wenden Sie sich bitte zuerst an Ihren Installateur oder
Fachhändler oder an

SVEBA-DAHLEN AB
S-513 82 FRISTAD,
Schweden
Tel.-Nr.: + 46 33 26 67 90
Fax-Nr.: + 46 33 26 67 76

Der Hersteller behält sich das Recht auf Maß- und Konstruktionsänderungen vor.

Innehåll	Table of contents	Inhalt	3
Instrumentpanel	Instrument panel	Instrumententafel	4-5
El. koppl. låda	Electrical box	El. Schaltkasten	6-7
Ånga	Steam	Dampf	8-11
Dörr	Door	Tür	12-15
Invendiga detaljer	Interior parts	Inwendige Teile	16-17
Kyla	Cooling	Kälte	18-19
Monteringsats	Mounting set	Montage satz	20-21

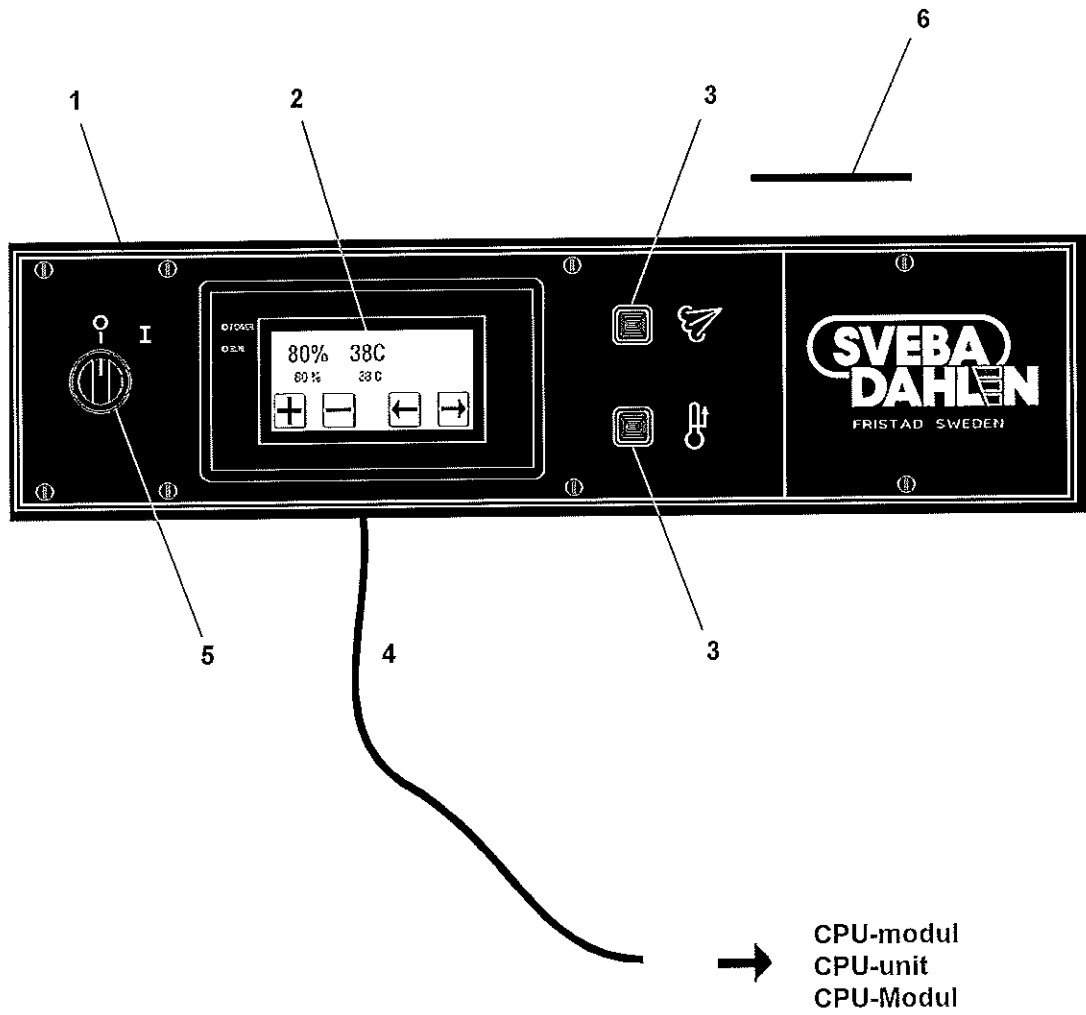



Instrumentpanel

Instrument panel

Instrumenttafel

Pos Fig. Teil	Best.nr Order No Best.Nr	Benämning	Description	Benennung	Anm. Notes Anm.
1	216303-01	Instrumentpanel	Instrument panel	Instrumenttafel	
2	60532-800	Operatörspanel	Programmable terminal	Instrumenttafel	
3	60506-800	Signallampa gul	Pilot lamp yellow	Signallampe gelb	
4	60532-801	Kabel	Cable	Kabel	
5	317026-10	Strömställare	Switch	Schalter	0-1
6	60580-800	Handtag	Handle	Handgriff	

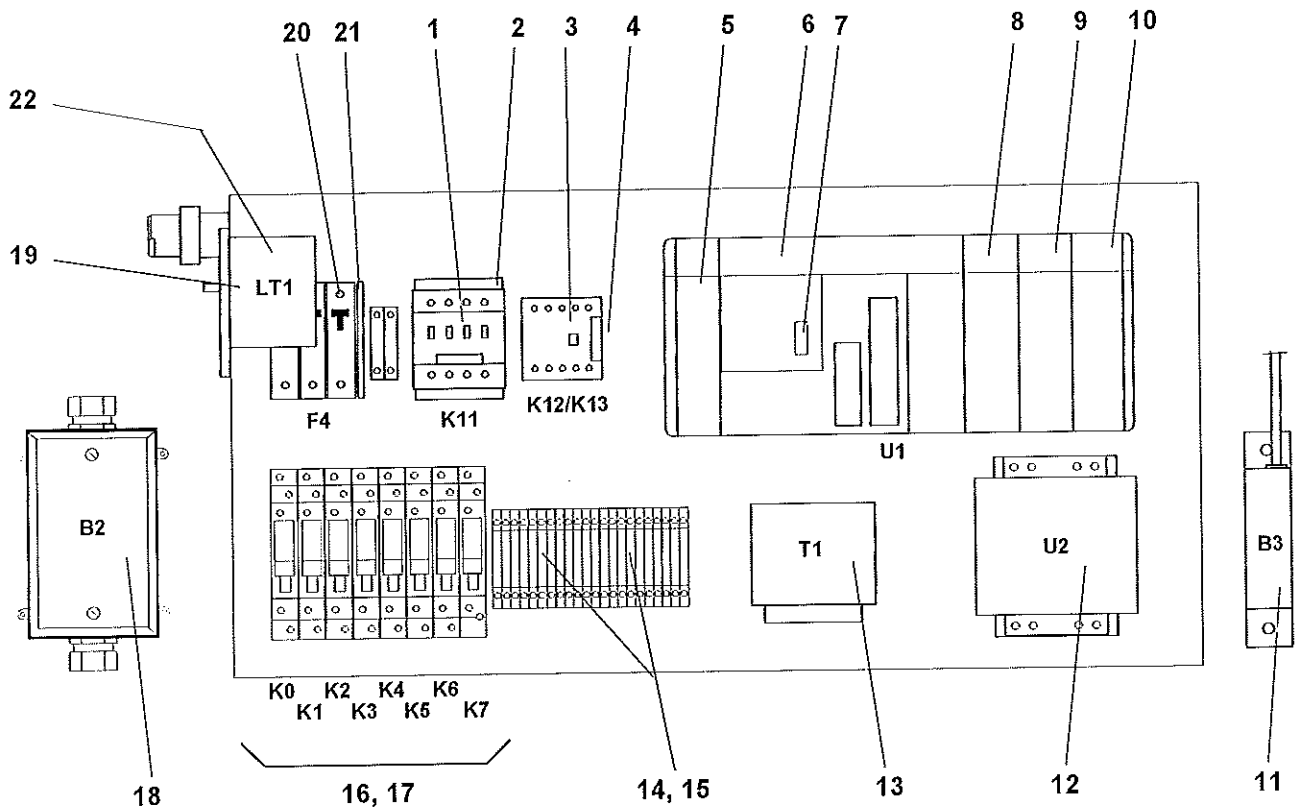
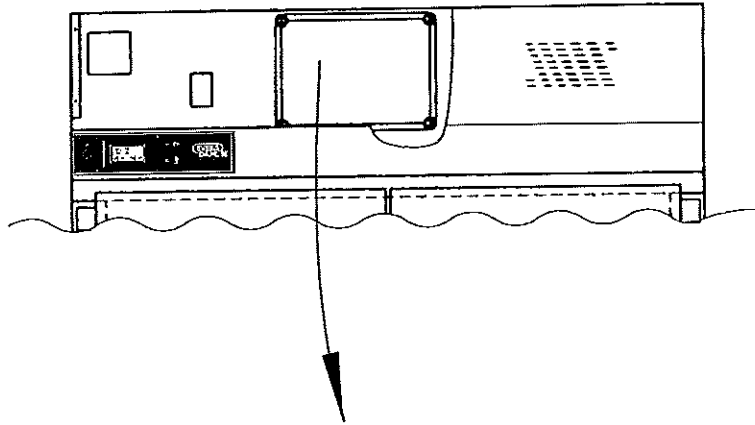

5-0004.CDR - 5-0030.TIF

Pos Fig. Teil	Best.nr Order No Best.Nr	Benämning	Description	Benennung		Anm. Notes Anm.
---------------------	--------------------------------	-----------	-------------	-----------	--	-----------------------

Kyl-Jäsrums 3x220V Retarder-Prover 3x220V Kühl-Gärraum 3x220V

1	60607-800	Kontaktor 24V	Contactora 24V	Schüts 24V	K11	HiK 3kW
1	60607-801	Kontaktor 24V	Contactora 24V	Schüts 24V	K11	HiK 6kW, 9kW
1	60607-802	Kontaktor 24V	Contactora 24V	Schüts 24V	K11	HiK 12kW
2	60381-810	Varistor	Varistor	Varistor		
3	60607-800	Kontaktor 24V	Contactora 24V	Schüts 24V	K12	
4	60381-810	Varistor	Varistor	Varistor		
5	60532-802	Nätödel	Power supply unit	Netzteil	U1	
6	60532-803	CPU-modul	CPU-unit	CPU-Modul	U1	
7	60532-807	Eprom	Memory cassette	Speicherkassette	U1	
8	60532-804	Utgångsmodul PNP	Output unit PNP	Ausgangsmodul PNP	U1	
9	60532-805	Analog-in-modul	Analog-in-unit	Analog-in-Modul	U1	
10	60532-806	Nätödel	Power supply unit	Netzteil	U1	
11	60534-800	Strömtransformator	Transformer	Strom Transformator	B3	
12	60532-808	Nätögregat	Power supply unit	Netzgerät	U2	
13	60605-800	Transformator	Transformer	Transformator	T1	
14	60604-801	Glasrörssäkring 10A	Glass tube fuse 10A	Glasrörsicherung 10A	F1	
15	60604-800	Glasrörssäkring 6,3A	Glass tube fuse 6,3A	Glasrörsicherung 6,3A	F2	
16	60532-809	Socket	Holder	Socket	K0-K7	
17	60532-810	Relä	Relay	Relais	K0-K7	
18	60539-800	Fukt och temp.givare	Humid.and temp.sensor	Feucht und Temp. Geber	B2	
19	60537-800	Fästadapter	Fastening	Befästigung	LT1	
20	60232-811	Automatsäkring 16A	Circuit breaker 16A	Automatsicherung 16A	F4	HiK 3kW
20	60232-823	Automatsäkring 32A	Circuit breaker 32A	Automatsicherung 32A	F4	HiK 6kW, 9kW
20	60232-827	Automatsäkring 40A	Circuit breaker 40A	Automatsicherung 40A	F4	HiK 12kW
21	60232-891	Shuntutlösare	Trip unit	Arbeitsstrom Auslöser	F4	
22	60603-800	Överhettningsskydd	Overheat protection	Überhitzschutz	LT1	0...200°C

Kyl-Jäsrums 3x380V Retarder-Prover 3x380V Kühl-Gärraum 3x380V

1	60607-800	Kontaktor 24V	Contactora 24V	Schüts 24V	K11	HiK 3kW, 6 kW, 9kW
1	60607-801	Kontaktor 24V	Contactora 24V	Schüts 24V	K11	HiK 12kW
2	60381-810	Varistor	Varistor	Varistor		HiK 3kW,6kW,9kW,12kW
3	60607-800	Kontaktor 24V	Contactora 24V	Schüts 24V	K12	
4	60381-810	Varistor	Varistor	Varistor		
5	60532-802	Nätödel	Power supply unit	Netzteil	U1	
6	60532-803	CPU-modul	CPU-unit	CPU-Modul	U1	
7	60532-807	Eprom	Memory cassette	Speicherkassette	U1	
8	60532-804	Utgångsmodul PNP	Output unit PNP	Ausgangsmodul PNP	U1	
9	60532-805	Analog-in-modul	Analog-in-unit	Analog-in-Modul	U1	
10	60532-806	Nätödel	Power supply unit	Netzteil	U1	
11	60534-800	Strömtransformator	Transformer	Strom Transformator	B3	
12	60532-808	Nätögregat	Power supply unit	Netzgerät	U2	
13	60605-800	Transformator	Transformer	Transformator	T1	
14	60604-801	Glasrörssäkring 10A	Glass tube fuse 10A	Glasrörsicherung 10A	F1	
15	60604-800	Glasrörssäkring 6,3A	Glass tube fuse 6,3A	Glasrörsicherung 6,3A	F2	
16	60532-809	Socket	Holder	Socket	K0-K7	
17	60532-810	Relä	Relay	Relais	K0-K7	
18	60539-800	Fukt och temp.givare	Humid.and temp.sensor	Feucht und Temp. Geber	B2	
19	60537-800	Fästadapter	Fastening	Befästigung	LT1	
20	60232-811	Automatsäkring 16A	Circuit breaker 16A	Automatsicherung 16A	F4	HiK 3kW, 6kW, 9kW
20	60232-819	Automatsäkring 25A	Circuit breaker 25A	Automatsicherung 25A	F4	HiK 12kW
21	60232-891	Shuntutlösare	Trip unit	Arbeitsstrom Auslöser	F4	
22	60603-800	Överhettningsskydd	Overheat protection	Überhitzschutz	LT1	0...200°C

Modell Model Modell
 98x100, 98x120, 98x150, 98x200
 150x100, 150x120, 150x150, 180x200, 180x210, 210x100, 210x150

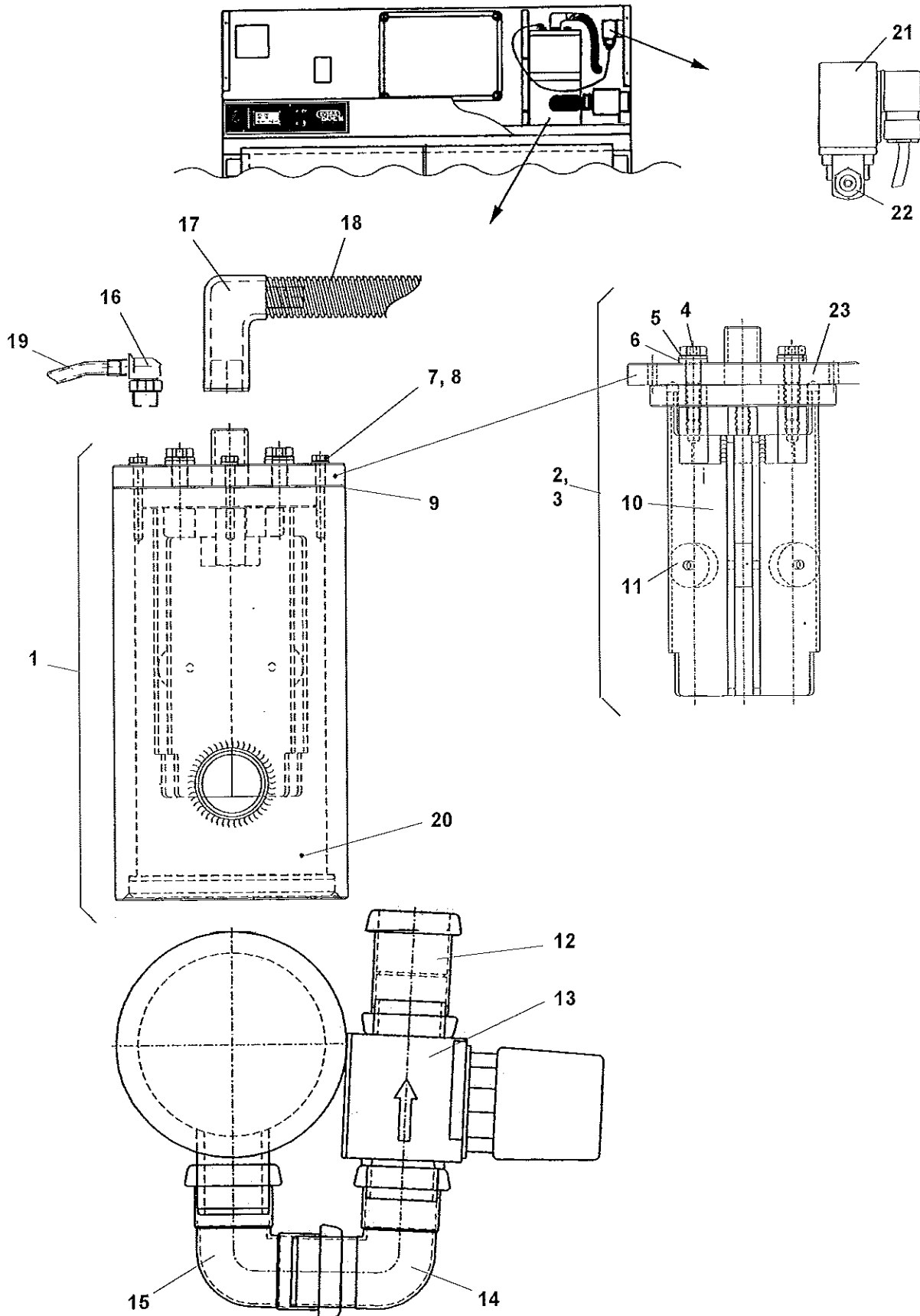

Pos Fig. Teil	Best.nr Order No Best.Nr	Benämning	Description	Benennung	Ant. Qty Anz.	Anm. Notes Anm.
1	320494-80	Ångkokare kpl. 1 hål	Steam cooker epl	Dampfkocher kpl		12mm*
1	320494-81	Ångkokare kpl. 1 hål	Steam cooker epl	Dampfkocher kpl		06mm**
2	216619-80	Lock med elektroder	Lid with electrode	Deckel mit Elektrode		12mm*
2	216619-81	Lock med elektroder	Lid with electrode	Deckel mit Elektrode		06mm**
3	511044-80	Montagesats lock	Mounting set, lid	Montage satz, Deckel		***
4	420030-01	Anslutningsbult	Connection bolt	Anschluss Bolzen		M6S 10x45 RFR
5	60570-800	Brieka	Washer	Scheibe		BRB 10,5x20x3
6	420032-01	Brieka	Washer	Scheibe		10x20x3
7	60552-800	Träskruv	Screw	Holzschraube		6x50 RFR
8	60570-801	Brieka	Washer	Scheibe		BRB 6,4x12 A2
9	420046-01	Packning	Gasket	Dichtung		Ø160 x Ø129 x 1
10	420041-80	Elektrod kompl.	Electrode epl.	Elektrode kpl		
11	420028-02	Distans 06mm	Distance 06mm	Distanzplatte 06mm		
11	420028-01	Distans 12mm	Distance 06mm	Distanzplatte 12mm		
12	60658-800	Rak dubbelmuff	Straight coupling	Gerade Muffe		Ø50
13	60555-800	Motor driven tömn.ventil	Motor. Draining valve	Motor. Entleerungsventil		
14	60659-800	Böj med en muff	Bend with one coupling	Winkel mit ein Muffe		Ø50/88,5
15	60660-800	Böj med två muff	Bend with two couplings	Winkel mit zwei Muffen		Ø50/88,5
16	60567-800	Vinkelanslutning	Angle nipple	Winkel Nippel		GCK-3/8
17	60517-800	Gummikrök	Rubber bend	Gummiwinkel		
18	65210-800	Ångslang	Steam hose	Dampfschlauch		Ø19
19	65211-800	Slang	Hose	Schlauch		PAN-8 x 1,25
20	216621-80	Behållare kpl. 1 hål	Container epl 1 hole	Behälter kpl		
21	60270-802	Magnetventil	Solenoid valve	Solenoid Ventil		
22	60554-800	Rak anslutning	Straight connection	Gerade Anschluss		CK-3/8-PK6KV
23	320487-80	Lock	Lid	Deckel		12mm*
23	320487-81	Lock	Lid	Deckel		06mm*

* Elektrodavstånd 12mm

** Elektrodavstånd 06mm

*** 511044-80					
Ant. Qty Anz.		Montagesats ångkokarlock	Mounting set Lid for steam cooker	Montage satz Deckel für Dampfkocher	
3	60552-800	Träskruv	Wood screw	Holzschraube	6x50 rfr
3	60570-801	Brieka	Washer	Scheibe	BRB 6,4x12x1,6 rfr
3	60017-329	Skruv	Screw	Schraube	M6S 5x16 fzb
3	60010-146	Brieka	Washer	Scheibe	5,3x15 rfr
1	420046-01	Packning	Gasket	Dichtung	Ø160 x Ø129 x 1

SVEBA DAHLIN	Ånga	Steam	Dampf	
-------------------------	------	-------	-------	--

Pos Fig. Teil	Best.nr Order No Best.Nr	Benämning	Description	Benennung	Ant. Qty Anz.	Anm. Notes Anm.
1	320494-80	Ångkokare kpl. 1 hål	Steam cooker cpl 1 hole	Dampfkocher kpl 1 loch		12mm*
1	320494-81	Ångkokare kpl. 1 hål	Steam cooker cpl 1 hole	Dampfkocher kpl 1 loch		06mm**
2	216619-80	Lock med elektroder	Lid with electrode	Deckel mit Elektrode		12mm*
2	216619-81	Lock med elektroder	Lid with electrode	Deckel mit Elektrode		06mm**
3	511044-80	Montagesats lock	Mounting set, lid	Montage satz, Deckel		***
4	420030-01	Anslutningsbult	Connection bolt	Anschluss Bolzen		M6S 10x45 RFR
5	60570-800	Brieka	Washer	Scheibe		BRB 10,5x20x3
6	420032-01	Brieka	Washer	Scheibe		10x20x3
7	60552-800	Träskruv	Screw	Holzschraube		6x50 RFR
8	60570-801	Brieka	Washer	Scheibe		BRB 6,4x12x1,6 rfr
9	420046-01	Packning	Gasket	Dichtung		Ø160 x Ø129 x 1
10	420041-80	Elektrod kompl.	Electrode cpl.	Elektrode kpl		
11	420028-02	Distans 06mm	Distance 06mm	Distanzplatte 06mm		
11	420028-01	Distans 12mm	Distance 06mm	Distanzplatte 12mm		
12	60658-800	Rak dubbelmuff	Straight coupling	Gerade Muffe		Ø50
13	60555-800	Motordriven tömn.ventil	Motor. Draining valve	Motor. Entleerungsventil		
14	60659-800	Böj med en muff	Bend with one coupling	Winkel mit ein Muffe		Ø50/88,5
15	60660-800	Böj med två muff	Bend with two couplings	Winkel mit zwei Muffen		Ø50/88,5
16	60567-800	Vinkelanslutning	Angle nipple	Winkel Nippel		GCK-3/8
17	60517-800	Gummikrök	Rubber bend	Gummiwinkel		
18	65210-800	Ångslang	Steam hose	Dampfschlauch		Ø19
19	65211-800	Slang	Hose	Schlauch		PAN-8 x 1,25
20	216621-80	Behållare kpl 1 hål	Container	Behälter		
21	60270-802	Magnetventil	Solenoid valve	Solenoid ventil		
22	60554-800	Rak anslutning	Straight connection	Gerade Anschluss		CK-3/8-PK6KV
23	320496-80	Ångkokare kpl. 2 hål 90°	Steam cook. cpl 2 hole 90°	Dampfkocher kpl 2 loch 90°		12mm*
23	320496-81	Ångkokare kpl. 2 hål 90°	Steam cook. cpl 2 hole 90°	Dampfkocher kpl 2 loch 90°		06mm**
24	216623-80	Behållare kpl. 2 hål 90°	Container cpl 2 hole 90°	Behälter kpl 2 loch		
25	60143-111	Propp	Plug	Propfen		DN10 3/8"
26	320487-80	Lock	Lid	Deckel		12mm*
26	320487-81	Lock	Lid	Deckel		06mm*

* Elektrodavstånd 12mm

** Elektrodavstånd 06mm

*** 511044-80					
Ant. Qty Anz.	Montagesats ångkokarloch	Mounting set Lid for steam cooker	Montage satz Deckel für Dampfkocher		
3	60552-800	Träskruv	Wood screw	Holzschraube	6x50 rfr
3	60570-801	Brieka	Washer	Scheibe	BRB 6,4x12x1,6 rfr
3	60017-329	Skruv	Screw	Schraube	M6S 5x16 fzb
3	60010-146	Brieka	Washer	Scheibe	5,3x15 rfr
1	420046-01	Packning	Gasket	Dichtung	Ø160 x Ø129 x 1

Modell Model Modell
98x100, 98x120, 98x150, 98x200

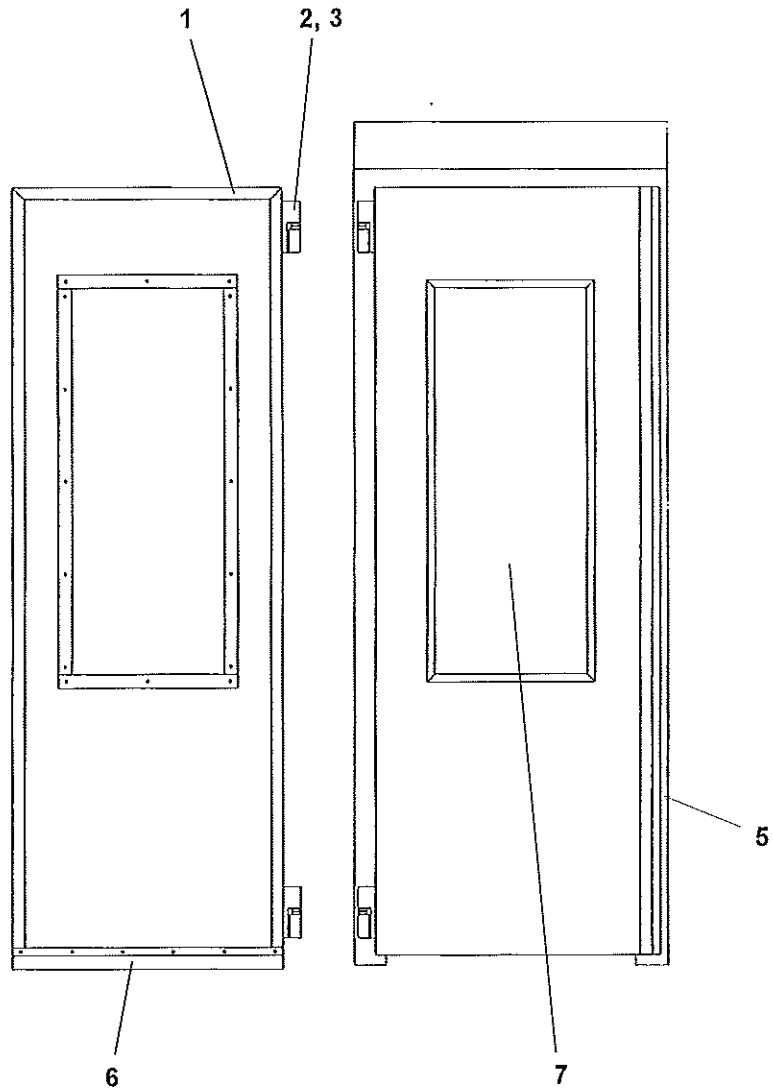

SVEBA DAHLIN	Dörr	Door	Tür	
-------------------------	------	------	-----	--

Pos Fig. Teil	Best.nr Order No Best.Nr	Benämning	Description	Benennung	Ant. Qty Anz.	Anm. Notes Anm.
1	60576-800	Dörrpackning	Door gasket	Tür - Dichtung	1	"98"
2	60577-800	Gångjärn komplett	Hinge complete	Scharnier	2	
3	60032-366	Skruv M6x12	Screw M6x12	Schraube M6x12	12	
5	60610-800	Dörrhandtag	Door handle	Türgriff	1	
6	60575-800	Gummlist	Rubber strip	Gummifassung	1	
7	60578-800	Isolerglas	Insulated glass	Isolierglas	1	

Modell Model Modell
 150x100, 150x120, 150x150, 180x120, 180x210, 180x285,
 210x100, 210x150, 210x240

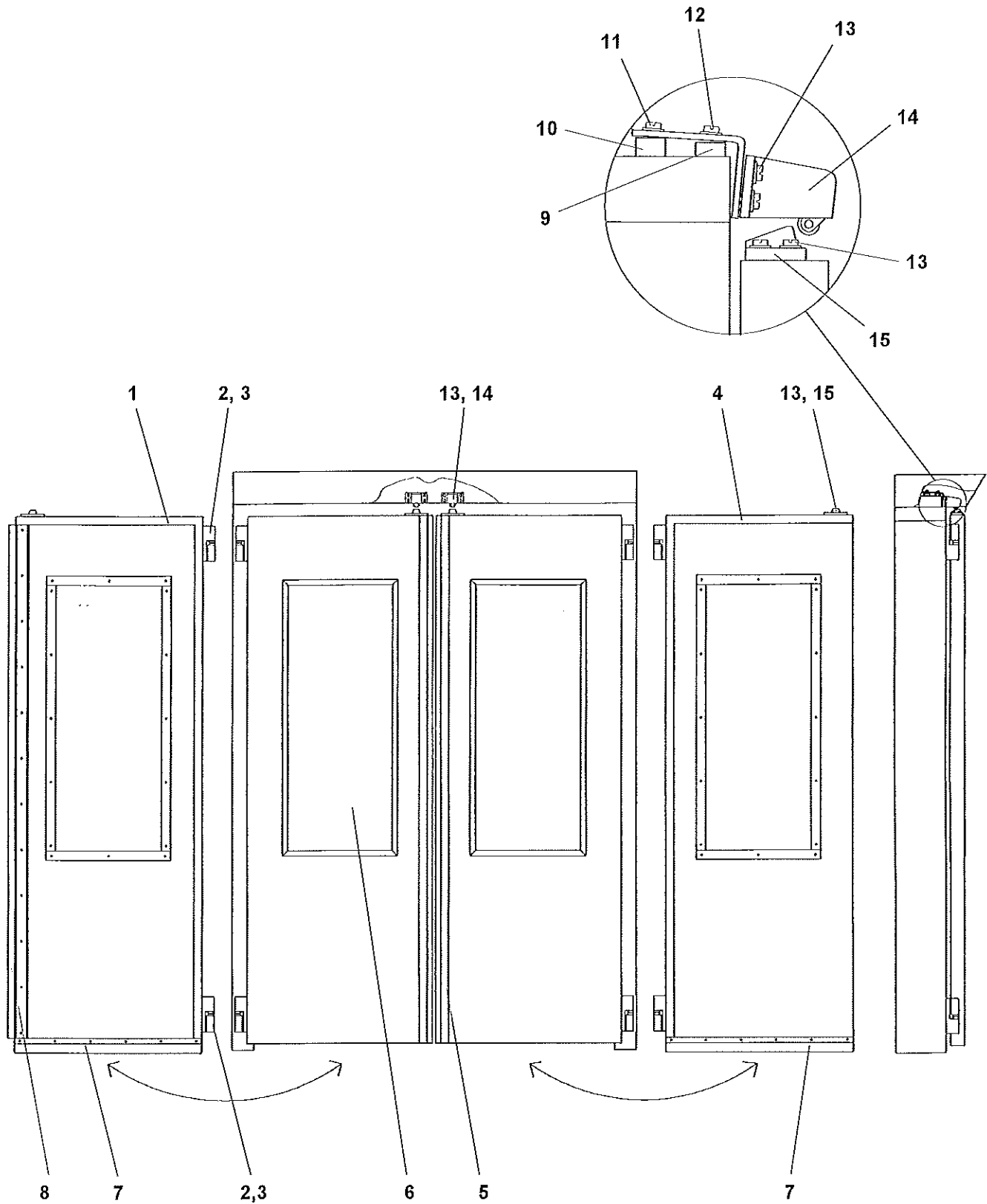

SVEBA DAHLIN	Dörr	Door	Tür	
-------------------------	------	------	-----	--

Pos Fig. Teil	Best.nr Order No Best.Nr	Benämning	Description	Benennung	Ant. Qty Anz.	Anm. Notes Anm.
1	60576-801	Dörrpackning vä.	Door gasket left	Tür - Dichtung links	1	"150"
1	60576-803	Dörrpackning vä.	Door gasket left	Tür - Dichtung links	1	"180"
1	60576-805	Dörrpackning vä.	Door gasket left	Tür - Dichtung links	1	"210"
2	60577-800	Gångjärn komplett	Hinge complete	Scharnier komplett	2	
3	60032-366	Skruv M6x12	Screw M6x12	Schraube M6x12	12	
4	60576-802	Dörrpackning hö.	Door gasket right	Tür - Dichtung recht	1	"150"
4	60576-804	Dörrpackning hö.	Door gasket right	Tür - Dichtung recht	1	"180"
4	60576-806	Dörrpackning hö.	Door gasket right	Tür - Dichtung recht	1	"210"
5	60610-800	Dörrhandtag	Door handle	Türgriff	1	
6	60578-800	Isoler glas	Insulated glass	Isolierglas	1	
7	60575-800	Gummilist	Rubber strip	Gummifassung	1	
8	60575-801	Gummilist	Rubber strip	Gummifassung	1	
9	60583-801	Distans	Distance	Distanzplatte	3*	h=9
10	60583-800	Distans	Distance	Distanzplatte	2*	h=12
11	60030-374	Skruv M6x30	Screw M6x30	Schraube M6x30	2*	
12	60030-370	Skruv M6x20	Screw M6x20	Schraube M6x20	3*	
13	60030-366	Skruv M6x12	Screw M6x12	Schraube M6x12	4	
14	60579-800	Dörrstängare	Door closer	Türschloss	1	
15	60579-801	Låsklack	Lock hook	Schlosshaken	1	

*) / Kyl-Jäsrum
/ Retarder/Prover
/ Kühl-Gärraum



Invändiga detaljer

Interior parts

Inwendige Teile

Pos Fig. Teil	Best.nr Order No Best.Nr	Benämning	Description	Benennung	Ant. Qty Anz.	Anm. Notes Anm.
1	60581-800	Belysningsarmatur komplett	Lighting fitting complete	Beleuchtung komplett	1	
2	60581-801	Kupa för belysningsarmatur	Shade for lighting fitting	Aussenglocke für Beleuchtung	1	
3	60581-802	Lysrör	Fluorescent tube	Leuchtröhre	1	590mm 18W
4	60584-800	Fläkt	Fan	Ventilator	*)	
5	60600-800	Element	Heating element	Heizkörper	**)	3000W 220V
6	60600-801	Element	Heating element	Heizkörper	**)	3000W 400V

Modell	Antal Fläktar	Värme effekt
98 x 100	1	3,0 kW
98 x 120	1	3,0 kW
98 x 150	2	6,0 kW
98 x 200	2	6,0 kW
150 x 100	2	6,0 kW
150 x 150	2	9,0 kW
180 x 100	2	6,0 kW
180 x 120	2	6,0 kW
180 x 210	2	9,0 kW
180 x 285	3	12,0 kW
210 x 100	2	6,0 kW
210 x 150	2	12,0 kW
210 x 240	3	12,0 kW

*) 1 / 98x100, 98x120

2 / 98x150, 98x200, 150x100, 150x150,
180x120, 180x210, 210x100, 210x150

3 / 180x285, 210x240

***) 1 / 98x100, 98x120

2 / 98x150, 98x200, 150x100, 150x150,
180x120, 210x100

3 / 180x210, 180x285, 210x240, 210x150

4 / 210x240

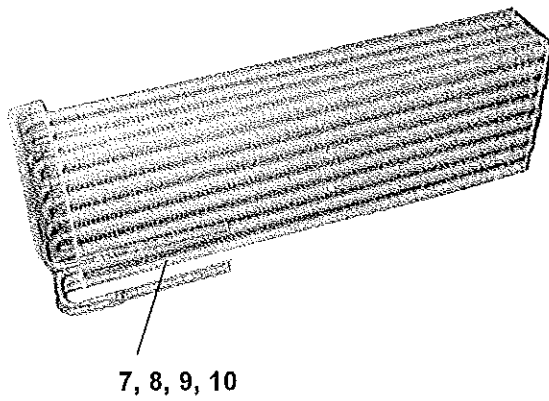
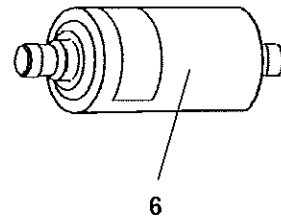
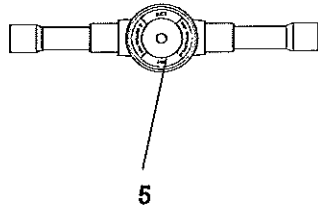
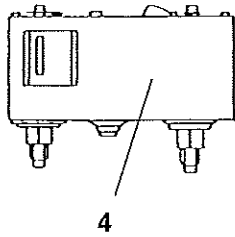
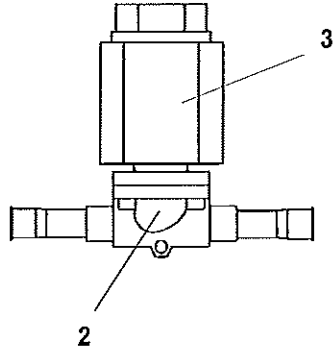
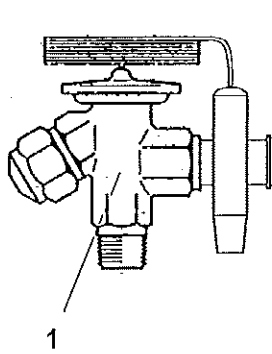

	Kyla	Cooling	Kälte	
--	------	---------	-------	--

Pos Fig. Teil	Best.nr Order No Best.Nr	Benämning	Description	Benennung	Ant. Qty Anz.	Anm. Notes Anm.
1	60594-800	Expansionsventil	Expansion valve	Expansion ventil		..
2	60595-800	Magnetventilhus kyla	Solenoid valve, retarder	Solenoid ventile, Ktil		
3	60595-801	Magnetventilspole kyla	Solenoid valve coil, retarder	Solenoid ventile, Ktil		
4	60596-800	Dubbelpressostat	Dual Pressure control	Doppel-Pressostat		
5	60597-800	Synglas	Sight glass	Gesichts-Glas		
6	60598-800	Torkfilter	Filter Drier	Filtergehäuse		
7	60601-801	Kylelement KJF 1	Refrigerating element KJF 1	Kühlelement KJF 1	*)	
8	60601-802	Kylelement KJF 2	Refrigerating element KJF 2	Kühlelement KJF 2	*)	
9	60601-803	Kylelement KJF 3	Refrigerating element KJF 3	Kühlelement KJF 3	*)	
10	60601-804	Kylelement KJF 4	Refrigerating element KJF 4	Kühlelement KJF 4	*)	

Modell	Kylaggregat	Kyleffekt vid -10°C förångning	Förångare *)	Dysa	Antal Fläktar	Värme effekt
98 x 100	CAE9460ZMHR	1,0 kW	KJF 1	01	1	3,0 kW
98 x 120	CAE9460ZMHR	1,0 kW	KJF 1	01	1	3,0 kW
98 x 150	CAJ9480ZMHR	1,4 kW	KJF 1	02	2	6,0 kW
98 x 200	CAJ9513ZMHR	2,1 kW	KJF 1	03	2	6,0 kW
150 x 100	CAJ9510ZMHR	1,7 kW	KJF 2	02	2	6,0 kW
150 x 150	CAJ9513ZMHR	2,1 kW	KJF 3	03	2	9,0 kW
180 x 100	CAJ9510ZMHR	1,7 kW	KJF 3	03	2	6,0 kW
180 x 120	CAJ9513ZMHR	2,1 kW	KJF 3	03	2	6,0 kW
180 x 210	TAJ4519ZHR	3,3 kW	KJF 4	04	2	9,0 kW
180 x 285	TFH4531ZHR	4,3 kW	KJF 4	05	3	12,0 kW
210 x 100	CAJ9513ZMHR	2,1 kW	KJF 3	03	2	6,0 kW
210 x 150	TAJ4519ZHR	3,3 kW	KJF 4	04	2	12,0 kW
210 x 240	TFH4531ZHR	4,3 kW	KJF 4	05	3	12,0 kW

1

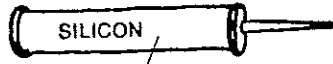

2



3

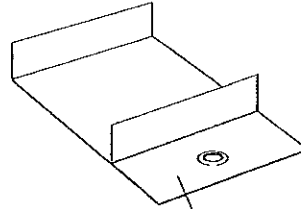

4

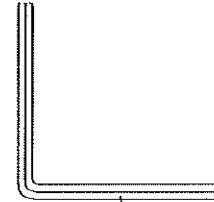

5



6

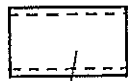

7



8

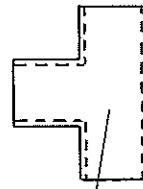

9



10

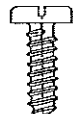

11



12

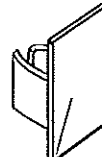

13

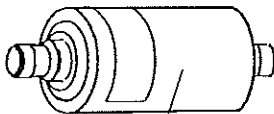

14

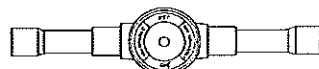

15

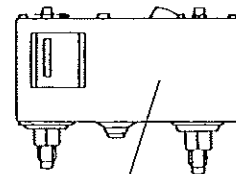

16



17

Pos Fig. Teil	Best.nr Order No Best.Nr	Benämning	Description	Benennung	Ant. Qty Anz.	Anm. Notes Anm.
1	511041-80	Monteringssats HiK	Mounting set HiK	Montage Satz HiK		"98"
1	511041-81	Monteringssats HiK	Mounting set HiK	Montage Satz HiK		"150", "180"
1	511041-82	Monteringssats HiK	Mounting set HiK	Montage Satz HiK		"210"
2	65100-800	Silikon	Silicone	Silikon	1	
3	60585-800	Täckplugg	Cover plug	Abdeckpropfen	20	
4	60611-800	Golvvinkel	Floor-angle	Bodenwinkel	4	
5	60587-800	Sexkantvinkel	Hexagon key	Sechskantschlüssel	1	
6	60590-800	Vinkel 90°	Angle 90°	Winkel 90°	8	32mm PVC
7	60589-800	Rak muff	Coupling	Verbindungsrohr	4	32mm PVC
8	60592-800	Rörklämma	Holder	Halter	4	32mm PVC
9	60591-800	T-rör	T-tube	T-rohr	1	32mm
10	60586-344	Skruv	Screw	Schraube	10	CSS B8x16 A2
11	60602-416	Skruv	Screw	Schraube	3	RXS B10x25 A2
12	60593-800	Plugg 8 x 40	Plug 8 x 40	Pfropf 8 x 40	3	
13	60577-801	Täckbricka gångjärn	Covering plate hinge	Abdeckblech Scharnier	*)	
14	60598-800	Torkfilter	Filter Drier	Filtergehäuse	1	
15	60597-800	Synglas	Sight glass	Gesichts-Glas	1	
16	60596-800	Dubbelpressostat	Dual Pressure control	Doppel-Pressostat	1	
17	420542-01	Schimsplåt	Plate	Platte	20	80 x 80mm

*) 4 / "98"
8 / "150", "180"
12 / "210"