

FERMATIC

Frys-Jäsrum Freezer-Prover Gärunterbrecher

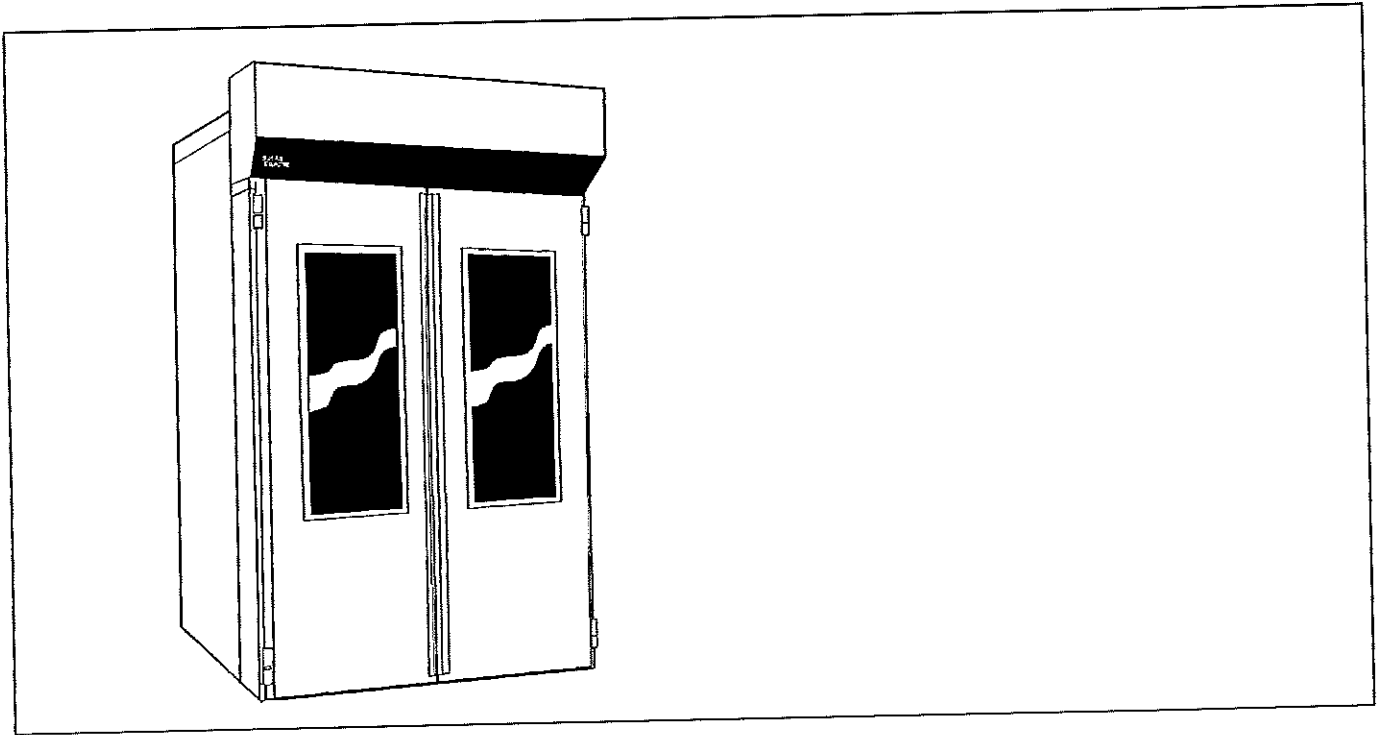

**Reservdelista
Spare Parts List
Ersatzteilliste**

Förutom denna RESERVDLSLISTA finns följande teknisk dokumentation:
DRIFT- SKÖTSEL- och INSTALLATIONSANVISNING 5:3520
ELKOPPLINGSSHEMA (medföljer frys-jäsrummet)

Vid förfrågan eller fel - kontakta installatören eller agenten i första hand eller

SVEBA-DAHLEN AB
513 82 FRISTAD
Tel. 033 266790
Fax 033 266776

Tillverkaren förbehåller sig rätten till mått- och konstruktionsändringar

The following technical documentation is available in addition to these
OPERATING, MAINTENANCE AND INSTALLATION MANUAL 5:3520
WIRING DIAGRAM (supplied with the freezer-prover)

Please direct all your questions, comments or technical problems regarding this
product to the SVEBA-DAHLEN dealer or directly to

SVEBA-DAHLEN AB
S-513 82 Fristad
Sweden
Tel. +46 33 26 67 90
Fax +46 33 26 67 76

Subject to changes without notice

Außer dieser Betriebs- Wartung- und Installationsanleitung gibt es die folgenden
technischen Beschreibungen:

BETRIEB, WARTUNG, INSTALLATION 5:3520
ELEKTR. SCHALTPLAN (dem Gärunterbrecher beigelegt)

Bei Fragen oder Störungen wenden Sie sich bitte zuerst an Ihren Installateur oder
Fachhändler oder an

SVEBA-DAHLEN AB
S-513 82 FRISTAD,
Schweden
Tel.-Nr.: + 46 33 26 67 90
Fax-Nr.: + 46 33 26 67 76

Der Hersteller behält sich das Recht auf Maß- und Konstruktionsänderungen vor.

Innehåll	Table of contents	Inhalt	3
Instrumentpanel	Instrument panel	Instrumententafel	4-5
El. koppl. låda	Electrical box	El. Schaltkasten	6-7
Ånga	Steam	Dampf	8-11
Dörr	Door	Tür	12-15
Invendiga detaljer	Interior parts	Inwendige Teile	16-17
Kyla	Cooling	Kälte	18-19
Monteringssats	Mounting set	Montage satz	20-21

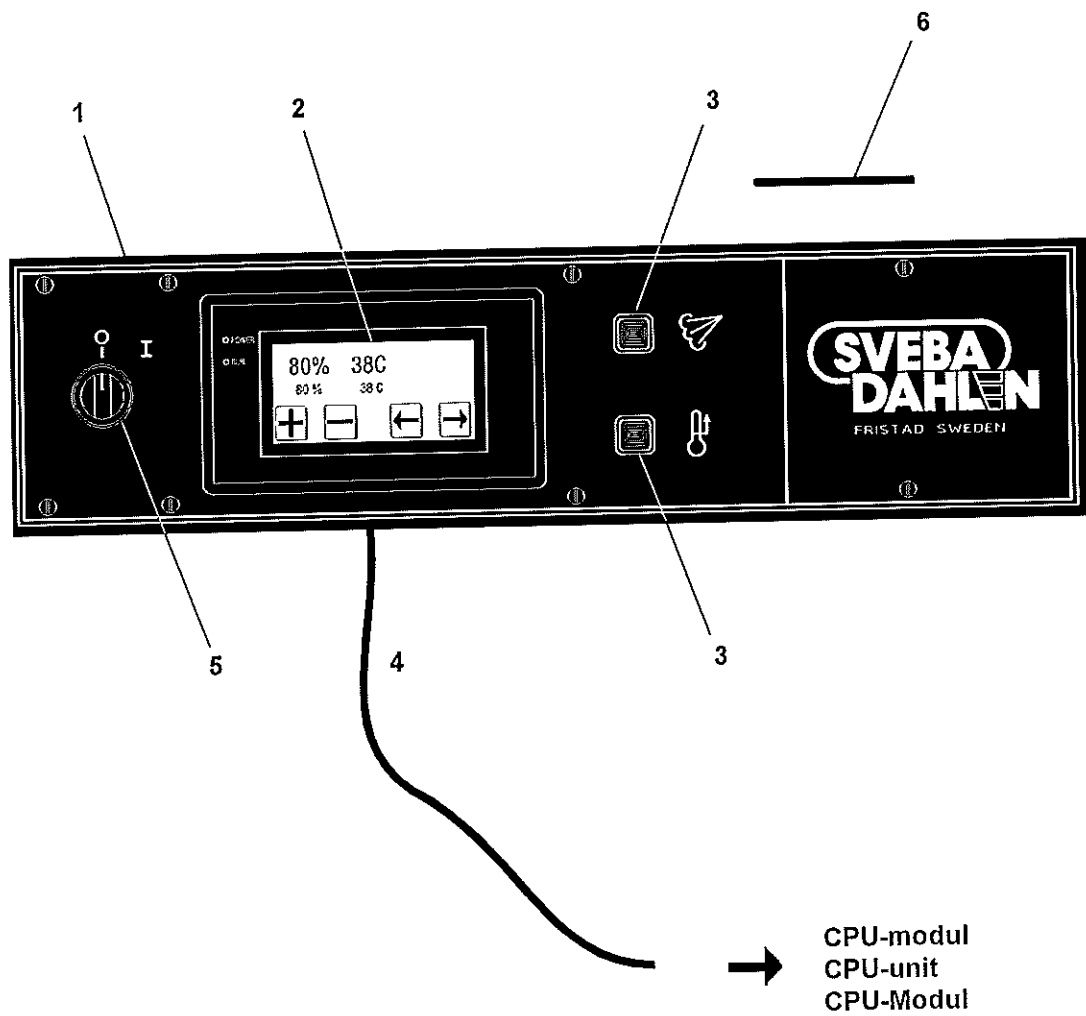



Instrumentpanel

Instrument panel

Instrumenttafel

Pos Fig. Teil	Best.nr Order No Best.Nr	Benämning	Description	Benennung	Anm. Notes Anm.
1	216303-01	Instrumentpanel	Instrument panel	Instrumenttafel	
2	60532-800	Operatörspanel	Programmable terminal	Instrumenttafel	
3	60506-800	Signallampa gul	Pilot lamp yellow	Signallampe gelb	
4	60532-801	Kabel	Cable	Kabel	
5	317026-10	Strömställare	Switch	Schalter	0-1
6	60580-800	Handtag	Handle	Handgriff	

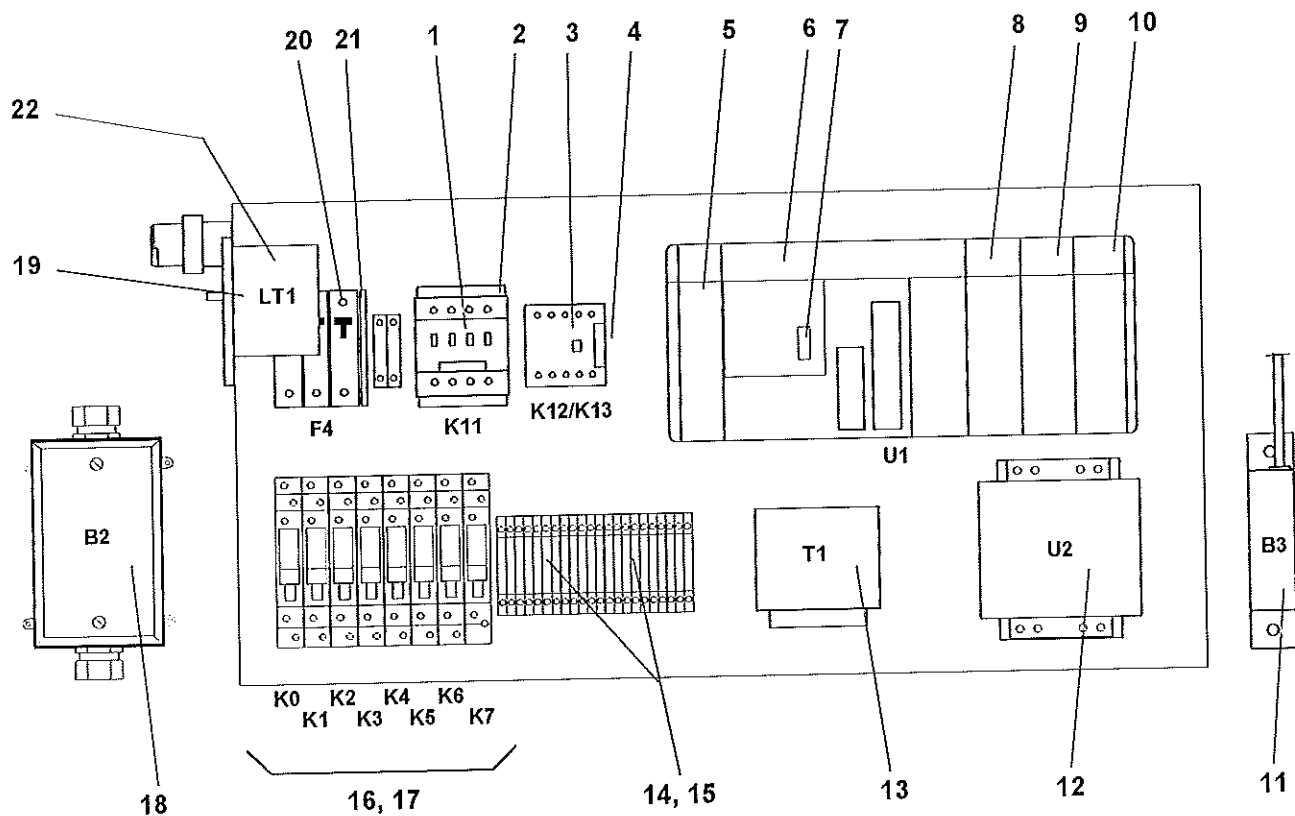
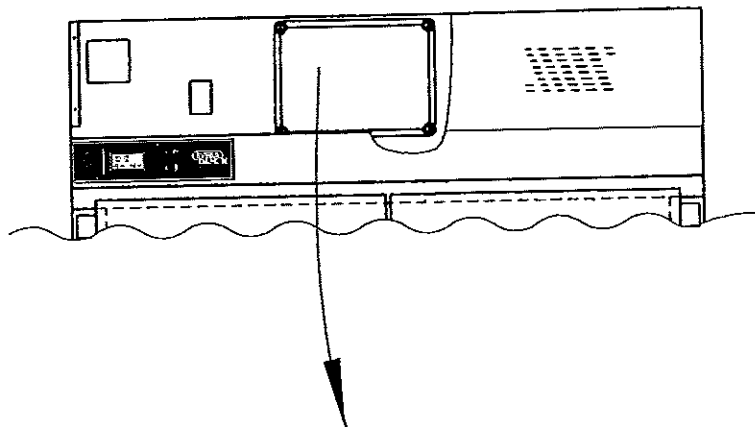

5-0004.CDR - 5-0030.TIF

	El koppl.låda	Electrical box	El.Schaltkasten	
---	---------------	----------------	-----------------	--

Pos Fig. Teil	Best.nr Order No Best.Nr	Benämning	Description	Benennung	Anm. Notes Anm.
---------------	--------------------------	-----------	-------------	-----------	-----------------

		Frys-Jäsrums 3x220V	Freezer-Prover 3x220V	Gärunterbrytare 3x220V		
1	60607-800	Kontaktor 24V	Contactora 24V	Schütz 24V	K11	HiK 3kW
1	60607-801	Kontaktor 24V	Contactora 24V	Schütz 24V	K11	HiK 6kW, 9kW
1	60607-802	Kontaktor 24V	Contactora 24V	Schütz 24V	K11	HiK 12kW
2	60381-810	Varistor	Varistor	Varistor		
3	60606-800	Kontaktor 24V	Contactora 24V	Schütz 24V	K12	
4	60608-802	Varistor	Varistor	Varistor		
5	60532-802	Nättdel	Power supply unit	Netzteil	U1	
6	60532-803	CPU-modul	CPU-unit	CPU-Modul	U1	
7	60532-807	Eprom	Memory cassette	Speicherkassette	U1	
8	60532-804	Utgångsmodul PNP	Output unit PNP	Ausgangsmodul PNP	U1	
9	60532-805	Analog-in-modul	Analog-in-unit	Analog-in-Modul	U1	
10	60532-806	Nättdel	Power supply unit	Netzteil	U1	
11	60534-800	Strömtransformator	Transformer	Strom Transformator	B3	
12	60532-808	Nättaggregat	Power supply unit	Netzgerät	U2	
13	60605-800	Transformator	Transformer	Transformator	T1	
14	60604-801	Glasrörsäkring 10A	Glass tube fuse 10A	Glasrohrsicherung 10A	F1	
15	60604-800	Glasrörsäkring 6,3A	Glass tube fuse 6,3A	Glasrohrsicherung 6,3A	F2	
16	60532-809	Sockel	Holder	Socket	K0-K7	
17	60532-810	Relä	Relay	Relais	K0-K7	
18	60539-800	Fukt och temp.givare	Humid.and temp.sensor	Feucht und Temp. Geber	B2	
19	60537-800	Fästadapter	Fastening	Befästigung	LT1	
20	60232-811	Automatsäkring 16A	Circuit breaker 16A	Automatsicherung 16A	F4	HiK 3kW
20	60232-823	Automatsäkring 32A	Circuit breaker 32A	Automatsicherung 32A	F4	HiK 6kW, 9kW
20	60232-827	Automatsäkring 40A	Circuit breaker 40A	Automatsicherung 40A	F4	HiK 12kW
21	60232-891	Shuntlösare	Trip unit	Arbetsstrom Auslöser	F4	
22	60603-800	Överhettningsskydd	Overheat protection	Überhitzschutz	LT1	0...200°C

		Frys-Jäsrums 3x380V	Freezer-Prover 3x380V	Gärunterbrytare 3x380V		
1	60606-800	Kontaktor 24V	Contactora 24V	Schütz 24V	K11	HiK 3kW
1	60607-800	Kontaktor 24V	Contactora 24V	Schütz 24V	K11	HiK 6 kW, 9kW
1	60607-801	Kontaktor 24V	Contactora 24V	Schütz 24V	K11	HiK 12kW
2	60608-802	Varistor	Varistor	Varistor		HiK 3kW
2	60381-810	Varistor	Varistor	Varistor		HiK 6kW, 9kW, 12kW
3	60606-800	Kontaktor 24V	Contactora 24V	Schütz 24V	K12	
4	60608-802	Varistor	Varistor	Varistor		
5	60532-802	Nättdel	Power supply unit	Netzteil	U1	
6	60532-803	CPU-modul	CPU-unit	CPU-Modul	U1	
7	60532-807	Eprom	Memory cassette	Speicherkassette	U1	
8	60532-804	Utgångsmodul PNP	Output unit PNP	Ausgangsmodul PNP	U1	
9	60532-805	Analog-in-modul	Analog-in-unit	Analog-in-Modul	U1	
10	60532-806	Nättdel	Power supply unit	Netzteil	U1	
11	60534-800	Strömtransformator	Transformer	Strom Transformator	B3	
12	60532-808	Nättaggregat	Power supply unit	Netzgerät	U2	
13	60605-800	Transformator	Transformer	Transformator	T1	
14	60604-801	Glasrörsäkring 10A	Glass tube fuse 10A	Glasrohrsicherung 10A	F1	
15	60604-800	Glasrörsäkring 6,3A	Glass tube fuse 6,3A	Glasrohrsicherung 6,3A	F2	
16	60532-809	Sockel	Holder	Socket	K0-K7	
17	60532-810	Relä	Relay	Relais	K0-K7	
18	60539-800	Fukt och temp.givare	Humid.and temp.sensor	Feucht und Temp. Geber	B2	
19	60537-800	Fästadapter	Fastening	Befästigung	LT1	
20	60232-811	Automatsäkring 16A	Circuit breaker 16A	Automatsicherung 16A	F4	HiK 3kW, 6kW, 9kW
20	60232-819	Automatsäkring 25A	Circuit breaker 25A	Automatsicherung 25A	F4	HiK 12kW
21	60232-891	Shuntlösare	Trip unit	Arbetsstrom Auslöser	F4	
22	60603-800	Överhettningsskydd	Overheat protection	Überhitzschutz	LT1	0...200°C

Modell Model Modell
 98x100, 98x120, 98x150, 98x200
 150x100, 150x120, 150x150, 180x200, 180x210, 210x100, 210x150

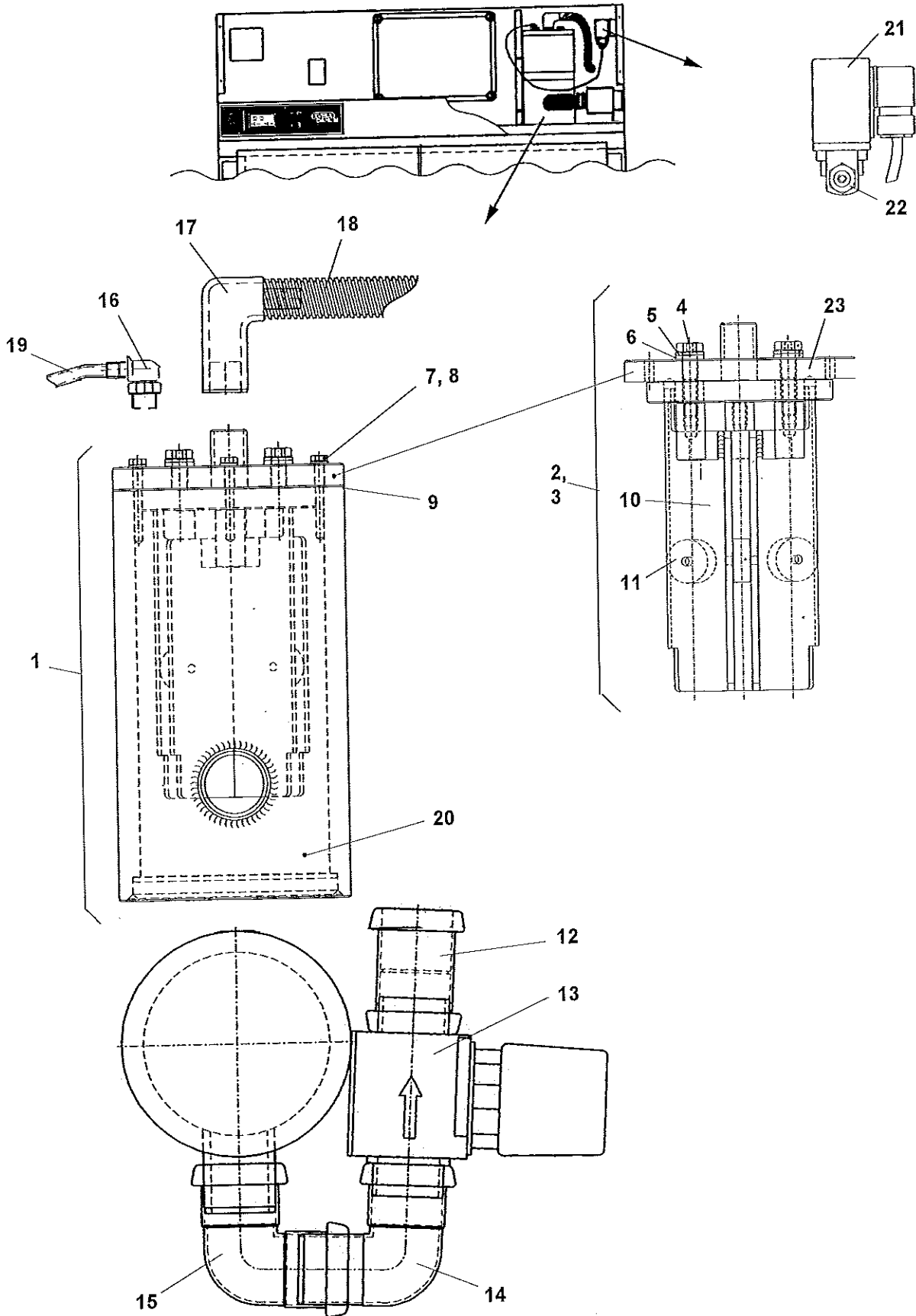

	Ånga	Steam	Dampf	

Pos Fig. Teil	Best.nr Order No Best.Nr	Benämning	Description	Benennung	Ant. Qty Anz.	Anm. Notes Anm.
1	320494-80	Ångkokare kpl. 1 hål	Steam cooker epl	Dampfkocher kpl		12mm*
1	320494-81	Ångkokare kpl. 1 hål	Steam cooker epl	Dampfkocher kpl		06mm**
2	216619-80	Lock med elektroder	Lid with electrode	Deckel mit Elektrode		12mm*
2	216619-81	Lock med elektroder	Lid with electrode	Deckel mit Elektrode		06mm**
3	511044-80	Montagesats lock	Mounting set, lid	Montage satz, Deckel		***
4	420030-01	Anslutningsbult	Connection bolt	Anschluss Bolzen		M6S 10x45 RFR
5	60570-800	Bricka	Washer	Scheibe		BRB 10,5x20x3
6	420032-01	Bricka	Washer	Scheibe		10x20x3
7	60552-800	Träskruv	Screw	Holzschraube		6x50 RFR
8	60570-801	Bricka	Washer	Scheibe		BRB 6,4x12 A2
9	420046-01	Packning	Gasket	Dichtung		Ø160 x Ø129 x 1
10	420041-80	Elektrod kompl.	Electrode epl.	Elektrode kpl		
11	420028-02	Distans 06mm	Distance 06mm	Distanzplatte 06mm		
11	420028-01	Distans 12mm	Distance 06mm	Distanzplatte 12mm		
12	60658-800	Rak dubbelmuff	Straight coupling	Gerade Muffe		Ø50
13	60555-800	Motordriven tömn.ventil	Motor. Draining valve	Motor. Entleerungsventil		
14	60659-800	Böj med en muff	Bend with one coupling	Winkel mit ein Muffe		Ø50/88,5
15	60660-800	Böj med två muff	Bend with two couplings	Winkel mit zwei Muffen		Ø50/88,5
16	60567-800	Vinkel-anslutning	Angle nipple	Winkel Nippel		GCK-3/8
17	60517-800	Gummikrök	Rubber bend	Gummiwinkel		
18	65210-800	Ångslang	Steam hose	Dampfschlauch		Ø19
19	65211-800	Slang	Hose	Schlauch		PAN-8 x 1,25
20	216621-80	Behållare kpl. 1 hål	Container epl 1 hole	Behälter kpl		
21	60270-802	Magnetventil	Solenoid valve	Solenoid Ventil		
22	60554-800	Rak anslutning	Straight connection	Gerade Anschluss		CK-3/8-PK6KV
23	320487-80	Lock	Lid	Deckel		12mm*
23	320487-81	Lock	Lid	Deckel		06mm*

* Elektroavstånd 12mm

** Elektroavstånd 06mm

*** 511044-80					
Ant. Qty Anz.	Montagesats ångkokarlock	Mounting set Lid for steam cooker	Montage satz Deckel für Dampfkocher		
3	60552-800	Träskruv	Wood screw	Holzschraube	6x50 rfr
3	60570-801	Bricka	Washer	Scheibe	BRB 6,4x12x1,6 rfr
3	60017-329	Skruv	Screw	Schraube	M6S 5x16 fzb
3	60010-146	Bricka	Washer	Scheibe	5,3x15 rfr
1	420046-01	Packning	Gasket	Dichtung	Ø160 x Ø129 x 1

Modell Model Modell

150x100, 150x120, 150x150, 180x200, 180x210, 210x100, 210x150

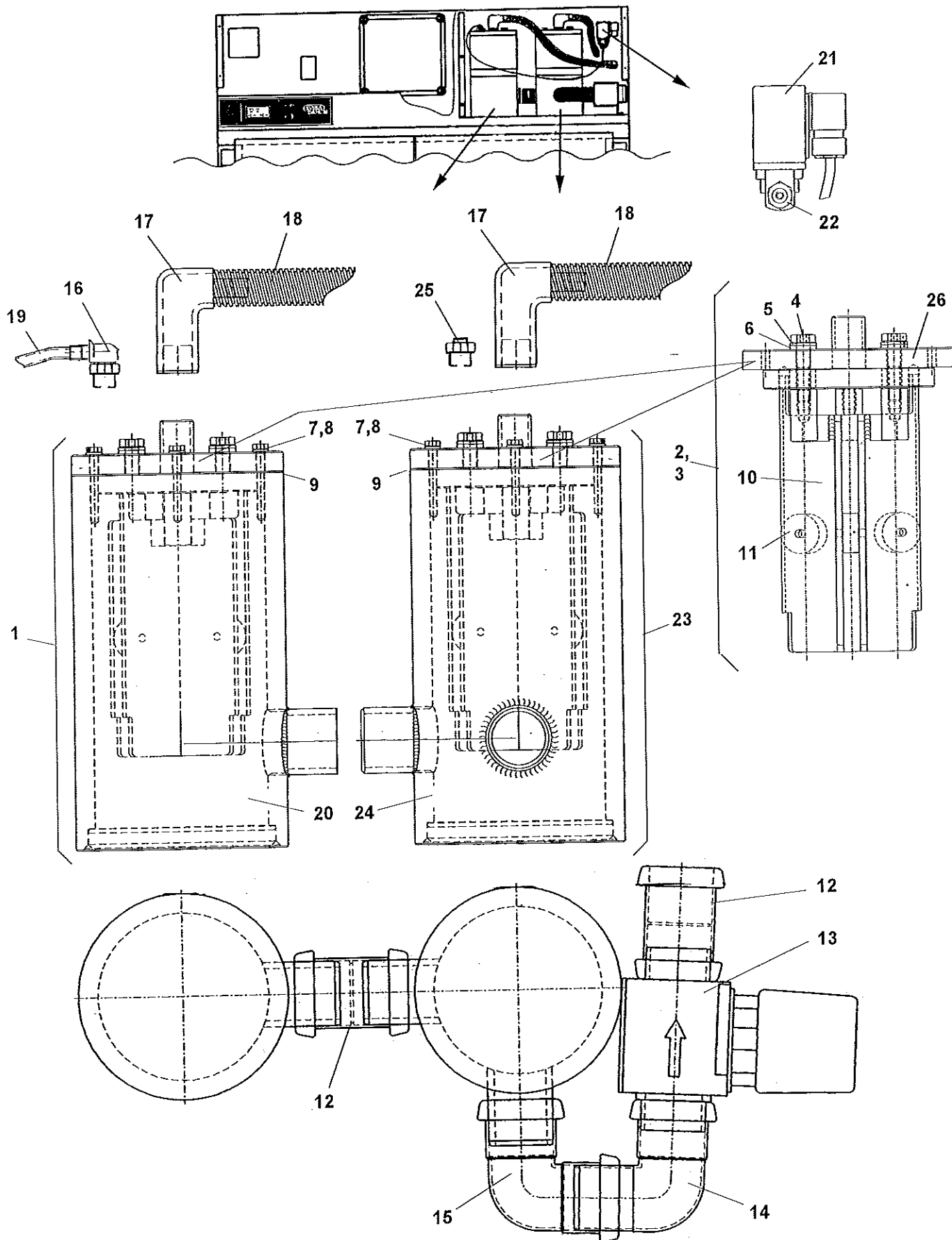

SVEBA DAHLIN	Ånga	Steam	Dampf
-------------------------	------	-------	-------

Pos Fig. Teil	Best.nr Order No Best.Nr	Benämning	Description	Benennung	Ant. Qty Anz.	Anm. Notes Anm.
1	320494-80	Ångkokare kpl. 1 hål	Steam cooker cpl 1 hole	Dampfkocher kpl 1 loch		12mm*
1	320494-81	Ångkokare kpl. 1 hål	Steam cooker cpl 1 hole	Dampfkocher kpl 1 loch		06mm**
2	216619-80	Lock med elektroder	Lid with electrode	Deckel mit Elektrode		12mm*
2	216619-81	Lock med elektroder	Lid with electrode	Deckel mit Elektrode		06mm**
3	511044-80	Montagesats lock	Mounting set, lid	Montage satz, Deckel		***
4	420030-01	Anslutningsbult	Connection bolt	Anschluss Bolzen		M6S 10x45 RFR
5	60570-800	Brieka	Washer	Scheibe		BRB 10,5x20x3
6	420032-01	Brieka	Washer	Scheibe		10x20x3
7	60552-800	Träskruv	Screw	Holzschraube		6x50 RFR
8	60570-801	Brieka	Washer	Scheibe		BRB 6,4x12x1,6 rfr
9	420046-01	Packning	Gasket	Dichtung		Ø160 x Ø129 x 1
10	420041-80	Elektrod kompl.	Electrode cpl.	Elektrode kpl		
11	420028-02	Distans 06mm	Distance 06mm	Distanzplatte 06mm		
11	420028-01	Distans 12mm	Distance 06mm	Distanzplatte 12mm		
12	60658-800	Rak dubbelmuff	Straight coupling	Gerade Muffe		Ø50
13	60555-800	Motordriven tömn.ventil	Motor. Draining valve	Motor. Entleerungsventil		
14	60659-800	Böj med en muff	Bend with one coupling	Winkel mit ein Muffe		Ø50/88,5
15	60660-800	Böj med två muff	Bend with two couplings	Winkel mit zwei Muffen		Ø50/88,5
16	60567-800	Vinkel-anslutning	Angle nipple	Winkel Nippel		GCK-3/8
17	60517-800	Gummikrök	Rubber bend	Gummiwinkel		
18	65210-800	Ångslang	Steam hose	Dampfschlauch		Ø19
19	65211-800	Slang	Hose	Schlauch		PAN-8 x 1,25
20	216621-80	Behållare kpl 1 hål	Container	Behälter		
21	60270-802	Magnetventil	Solenoid valve	Solenoid ventil		
22	60554-800	Rak anslutning	Straight connection	Gerade Anschluss		CK-3/8-PK6KV
23	320496-80	Ångkokare kpl. 2 hål 90°	Steam cook. cpl 2 hole 90°	Dampfkocher kpl 2 loch 90°		12mm*
23	320496-81	Ångkokare kpl. 2 hål 90°	Steam cook. cpl 2 hole 90°	Dampfkocher kpl 2 loch 90°		06mm**
24	216623-80	Behållare kpl. 2 hål 90°	Container cpl 2 hole 90°	Behälter kpl 2 loch		
25	60143-111	Propp	Plug	Propfen		DN10 3/8"
26	320487-80	Lock	Lid	Deckel		12mm*
26	320487-81	Lock	Lid	Deckel		06mm*

* Elektroavstånd 12mm

** Elektroavstånd 06mm

*** 511044-80					
Ant. Qty Anz.	Montagesats ångkokarlock	Mounting set Lid for steam cooker	Montage satz Deckel für Dampfkocher		
3	60552-800	Träskruv	Wood screw	Holzschraube	6x50 rfr
3	60570-801	Brieka	Washer	Scheibe	BRB 6,4x12x1,6 rfr
3	60017-329	Skruv	Screw	Schraube	M6S 5x16 fzb
3	60010-146	Brieka	Washer	Scheibe	5,3x15 rfr
1	420046-01	Packning	Gasket	Dichtung	Ø160 x Ø129 x 1

Modell Model Modell
98x100, 98x120, 98x150, 98x200

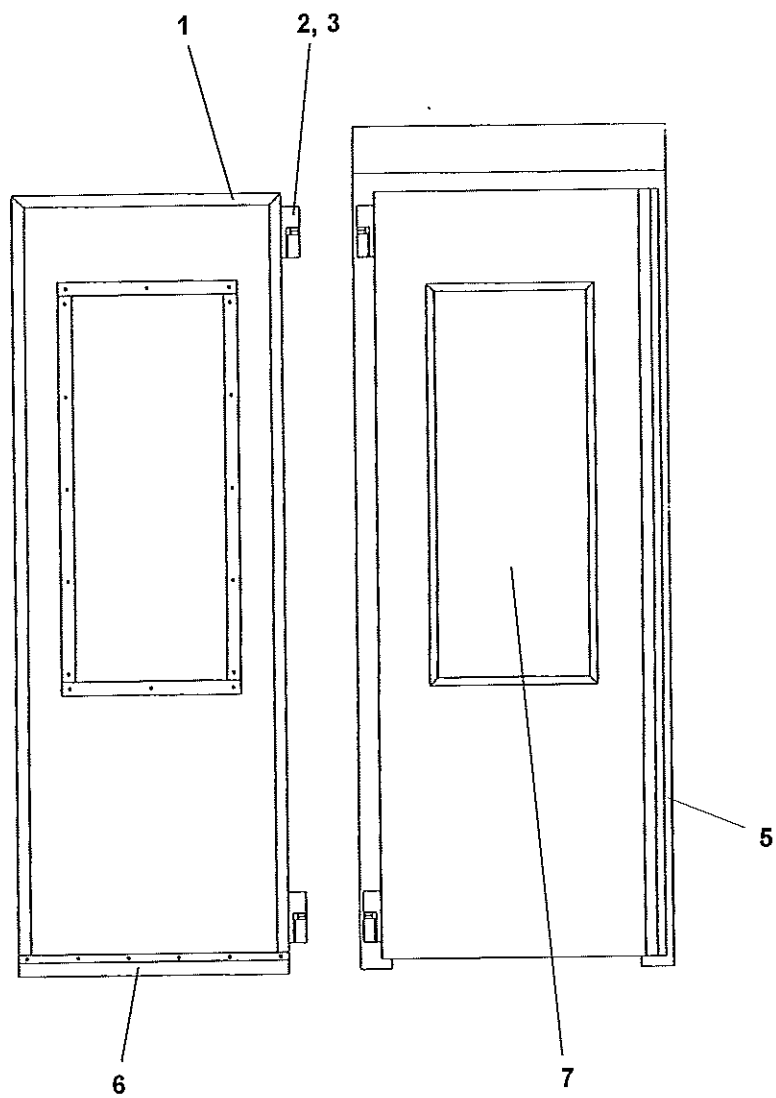

SVEBA DAHLIN	Dörr	Door	Tür	
-------------------------	------	------	-----	--

Pos Fig. Teil	Best.nr Order No Best.Nr	Benämning	Description	Benennung	Ant. Qty Anz.	Anm. Notes Anm.
1	60576-800	Dörrpackning	Door gasket	Tür - Dichtung	1	"98"
2	60577-800	Gångjärn komplett	Hinge complete	Scharnier	2	
3	60032-366	Skruv M6x12	Screw M6x12	Schraube M6x12	12	
5	60610-800	Dörrhandtag	Door handle	Türgriff	1	
6	60575-800	Gummlist	Rubber strip	Gummifassung	1	
7	60578-800	Isolerglas	Insulated glass	Isolierglas	1	

Modell Model Modell
 150x100, 150x120, 150x150, 180x120, 180x210, 180x285,
 210x100, 210x150, 210x240

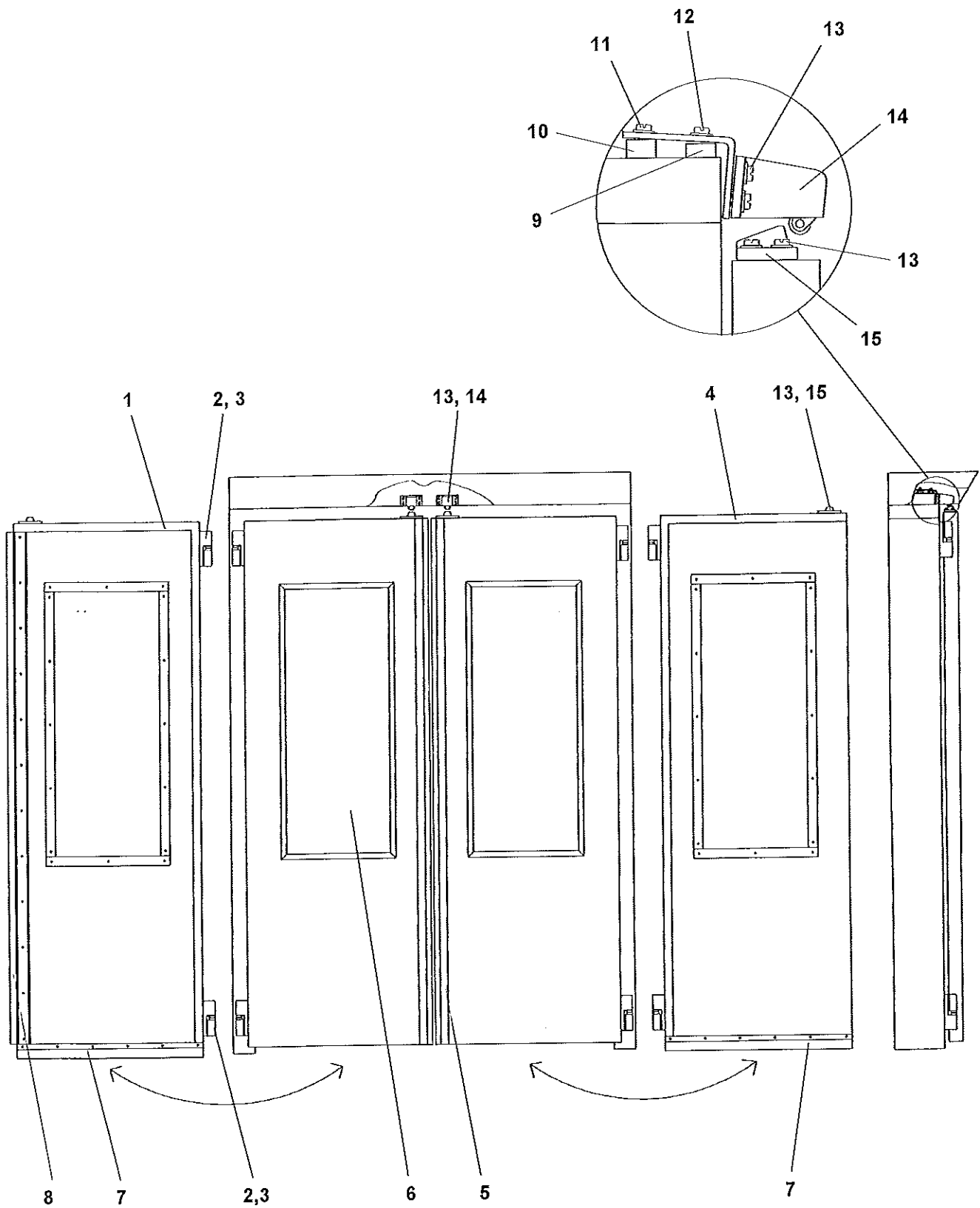

SVEBA DAHLIN	Dörr	Door	Tür	
-------------------------	------	------	-----	--

Pos Fig. Teil	Best.nr Order No Best.Nr	Benämning	Description	Benennung	Ant. Qty Anz.	Ann. Notes Ann.
1	60576-801	Dörrpackning vä.	Door gasket left	Tür - Dichtung links	1	"150"
1	60576-803	Dörrpackning vä.	Door gasket left	Tür - Dichtung links	1	"180"
1	60576-805	Dörrpackning vä.	Door gasket left	Tür - Dichtung links	1	"210"
2	60577-800	Gångjärn komplett	Hinge complete	Scharnier komplett	2	
3	60032-366	Skruv M6x12	Screw M6x12	Schraube M6x12	12	
4	60576-802	Dörrpackning hö.	Door gasket right	Tür - Dichtung recht	1	"150"
4	60576-804	Dörrpackning hö.	Door gasket right	Tür - Dichtung recht	1	"180"
4	60576-806	Dörrpackning hö.	Door gasket right	Tür - Dichtung recht	1	"210"
5	60610-800	Dörrhandtag	Door handle	Türgriff	1	
6	60578-800	Isolerglass	Insulated glass	Isolierglas	1	
7	60575-800	Gummilist	Rubber strip	Gummifassung	1	
8	60575-801	Gummilist	Rubber strip	Gummifassung	1	
9	60583-801	Distans	Distance	Distanzplatte	3*	h=9
10	60583-800	Distans	Distance	Distanzplatte	2*	h=12
11	60030-374	Skruv M6x30	Screw M6x30	Schraube M6x30	2*	
12	60030-370	Skruv M6x20	Screw M6x20	Schraube M6x20	3*	
13	60030-366	Skruv M6x12	Screw M6x12	Schraube M6x12	4	
14	60579-800	Dörrstängare	Door closer	Türschloss	1	
15	60579-801	Låsklack	Lock hook	Schlosshaken	1	

*) / Frys-Jäsrum
/ Freezer-Prover
/ Gärunterbrecher



Invändiga detaljer

Interior parts

Inwendige Teile

Pos Fig. Teil	Best.nr Order No Best.Nr	Benämning	Description	Benennung	Ant. Qty Anz.	Anm. Notes Anm.
1	60581-800	Belysningsarmatur komplett	Lighting fitting complete	Beleuchtung komplett	1	
2	60581-801	Kupa för belysningsarmatur	Shade for lighting fitting	Aussenglocke für Beleuchtung	1	
3	60581-802	Lysrör	Fluorescent tube	Leuchtröhre	1	590mm 18W
4	60584-800	Fläkt	Fan	Ventilator	*)	
5	60600-800	Element	Heating element	Heizkörper	**)	3000W 220V
6	60600-801	Element	Heating element	Heizkörper	**)	3000W 400V

Modell	Antal Fläktar	Värme effekt
98 x 100	1	3,0 kW
98 x 120	1	3,0 kW
98 x 150	2	6,0 kW
98 x 200	2	6,0 kW
150 x 100	2	6,0 kW
150 x 150	2	9,0 kW
180 x 100	2	6,0 kW
180 x 120	2	6,0 kW
180 x 210	2	9,0 kW
180 x 285	3	12,0 kW
210 x 100	2	6,0 kW
210 x 150	2	12,0 kW
210 x 240	3	12,0 kW

*) 1 / 98x100, 98x120

2 / 98x150, 98x200, 150x100, 150x150,
180x120, 180x210, 210x100, 210x150

3 / 180x285, 210x240

***) 1 / 98x100, 98x120

2 / 98x150, 98x200, 150x100, 150x150,
180x120, 210x100

3 / 180x210, 180x285, 210x240, 210x150

4 / 210x240

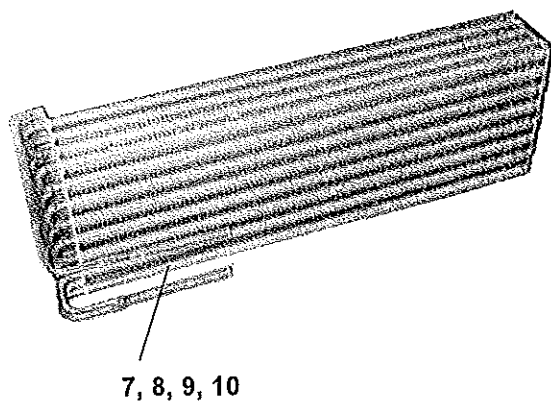
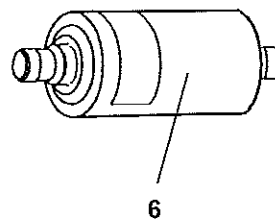
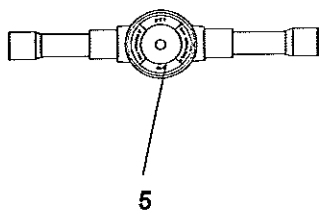
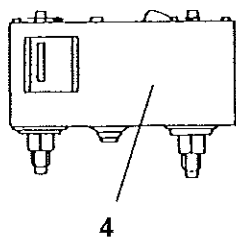
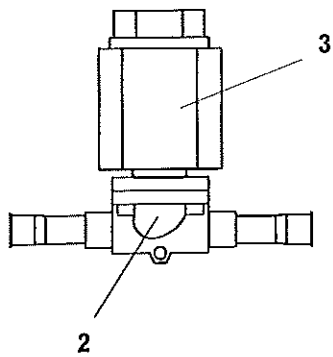
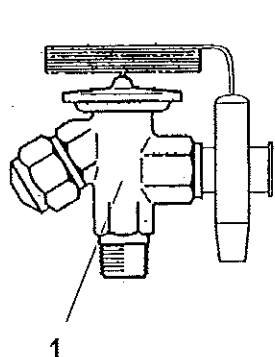

	Kyla	Cooling	Kälte	
--	------	---------	-------	--

Pos Fig. Teil	Best.nr Order No Best.Nr	Benämning	Description	Benennung	Ant. Qty Anz.	Anm. Notes Anm.
1	60594-800	Expansionsventil	Expansion valve	Expansion ventil		..
2	60595-800	Magnetventillhus kyla	Solenoid valve, retarder	Solenoid ventile, Ktil		
3	60595-801	Magnetventilspole kyla	Solenoid valve coil, retarder	Solenoid ventile, Ktil		
4	60596-800	Dubbelpressostat	Dual Pressure control	Doppel-Pressostat		
5	60597-800	Synglas	Sight glass	Gesichts-Glas		
6	60598-800	Torkfilter	Filter Drier	Filtergehäuse		
7	60601-801	Kylelement KJF 1	Refrigerating element KJF 1	Kühlelement KJF 1	*)	
8	60601-802	Kylelement KJF 2	Refrigerating element KJF 2	Kühlelement KJF 2	*)	
9	60601-803	Kylelement KJF 3	Refrigerating element KJF 3	Kühlelement KJF 3	*)	
10	60601-804	Kylelement KJF 4	Refrigerating element KJF 4	Kühlelement KJF 4	*)	

Modell	Frysaggregat	Kyleffekt vid -10°C förångning	Förångare *)	Dysa	Antal Fläktar	Värme effekt
98 x 100	CAJ2464ZBR	1,2 kW	KJF 1	01	1	3,0 kW
98 x 120	CAJ2464ZBR	1,2 kW	KJF 1	01	1	3,0 kW
98 x 150	TFH2480ZBR	1,8 kW	KJF 1	02	2	6,0 kW
98 x 200	TFH2511ZBR	2,4 kW	KJF 1	03	2	6,0 kW
150 x 100	TFH2480ZBR	1,8 kW	KJF 2	02	2	6,0 kW
150 x 150	TFH2511ZBR	2,4 kW	KJF 3	03	2	9,0 kW
180 x 100	TFH2480ZBR	1,8 kW	KJF 3	03	2	6,0 kW
180 x 120	TFH2511ZBR	2,4 kW	KJF 3	03	2	6,0 kW
180 x 210	TAHD2616ZBR	3,3 kW	KJF 4	04	2	9,0 kW
180 x 285	TAHD2522ZBR	4,1 kW	KJF 4	05	3	12,0 kW
210 x 100	TFH2511ZBR	2,4 kW	KJF 3	03	2	6,0 kW
210 x 150	TAHD2616ZBR	3,3 kW	KJF 4	04	2	12,0 kW
210 x 240	TAHD2522ZBR	4,1 kW	KJF 4	05	3	12,0 kW

1

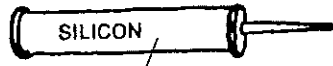

2



3

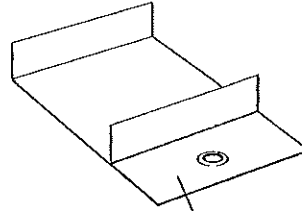

4

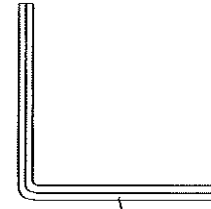

5

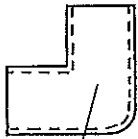

6

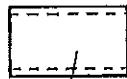

7

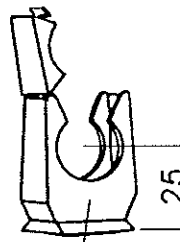

8

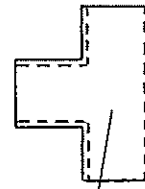

9

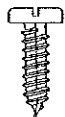

10



11



12



13

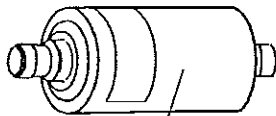

14



15

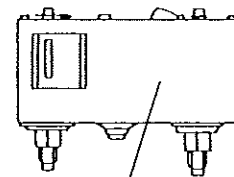

16

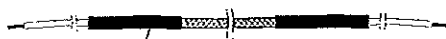

17



18



Monteringssats

Mounting set

Montage satz

Pos Fig. Teil	Best.nr Order No Best.Nr	Benämning	Description	Benennung	Ant. Qty Anz.	Anm. Notes Anm.
1	511042-80	Monteringssats HiF	Mounting set HiF	Montage Satz HiF		"98"
1	511042-81	Monteringssats HiF	Mounting set HiF	Montage Satz HiF		"150"
1	511042-82	Monteringssats HiF	Mounting set HiF	Montage Satz HiF		"180"
1	511042-83	Monteringssats HiF	Mounting set HiF	Montage Satz HiF		"210"
2	65100-800	Silikon	Silicone	Silikon	1	
3	60585-800	Täckplugg	Cover plug	Abdeckpropfen	20	
4	60611-800	Golvvinkel	Floor-angle	Bodenwinkel	4	
5	60587-800	Sexkantvinkel	Hexagon key	Sechskantschlüssel	1	8mm
6	60590-800	Vinkel	Angle	Winkel	8	32mm PVC
7	60589-800	Rak muff	Coupling	Verbindungsrohr	4	32mm PVC
8	60592-800	Rörklämma	Holder	Halter	4	32mm PVC
9	60591-800	T-rör	T-tube	T-rohr	1	32mm
10	60586-344	Skruv	Screw	Schraube	10	CSS B8x16 A2
11	60602-416	Skruv	Screw	Schraube	3	RXS B10x25 A2
12	60593-800	Plugg 8 x 40	Plug 8 x 40	Pfropf 8 x 40	3	
13	60577-801	Täckbricka gångjärn	Covering plate hinge	Abdeckblech Scharnier	*)	
14	60598-800	Torkfilter	Filter Drier	Filtergehäuse	1	
15	60597-800	Synglas	Sight glass	Gesichts-Glas	1	
16	60596-800	Dubbelpressostat	Dual Pressure control	Doppel-Pressostat	1	
17	60609-800	Värmekabel	Heating cable	Wärmekabel		"98"
17	60609-801	Värmekabel	Heating cable	Wärmekabel		"150"
17	60609-802	Värmekabel	Heating cable	Wärmekabel		"180"
17	60609-803	Värmekabel	Heating cable	Wärmekabel		"210"
18	420542-01	Schimsplåt	Plate	Platte	20	80 x 80mm

*) 4 / "98"
8 / "150", "180"
12 / "210"